

SECTION A-A

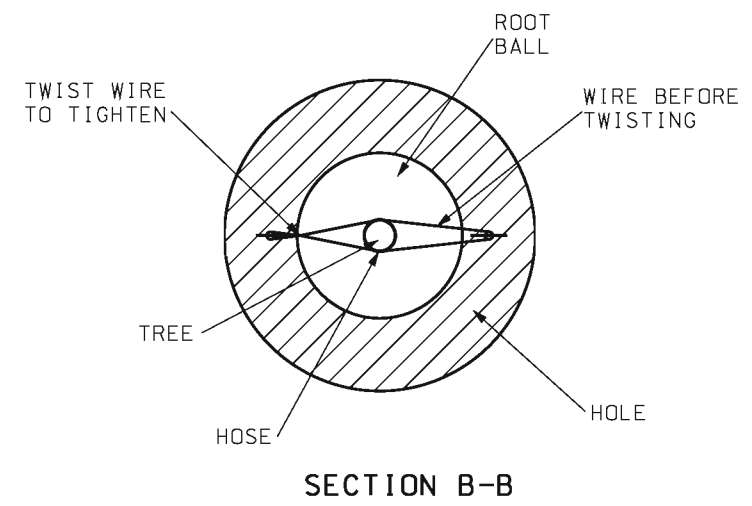

SECTION B-B

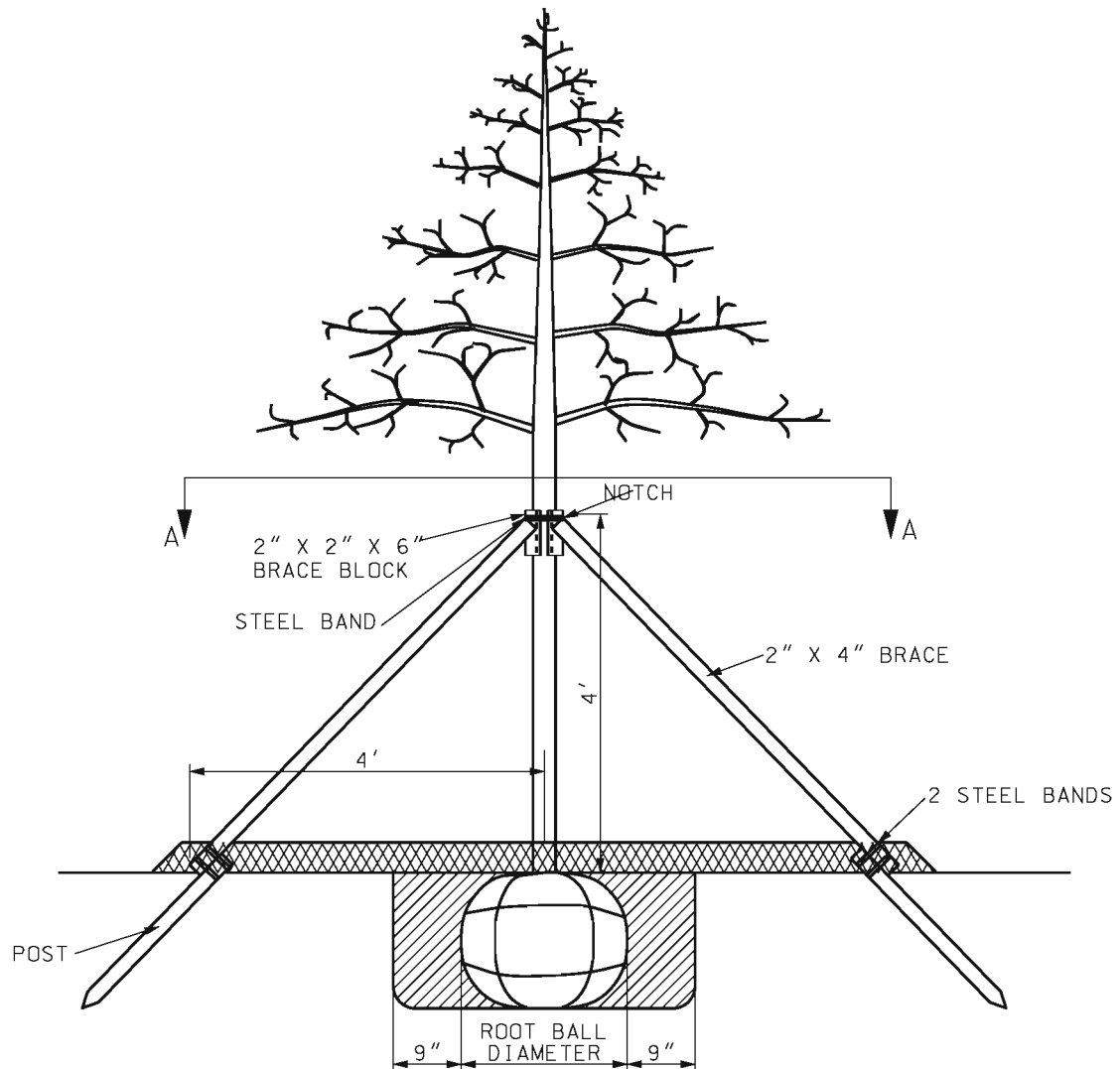

METHOD OF SUPPORTING DECIDUOUS TREES  
3" CALIBER OR LARGER

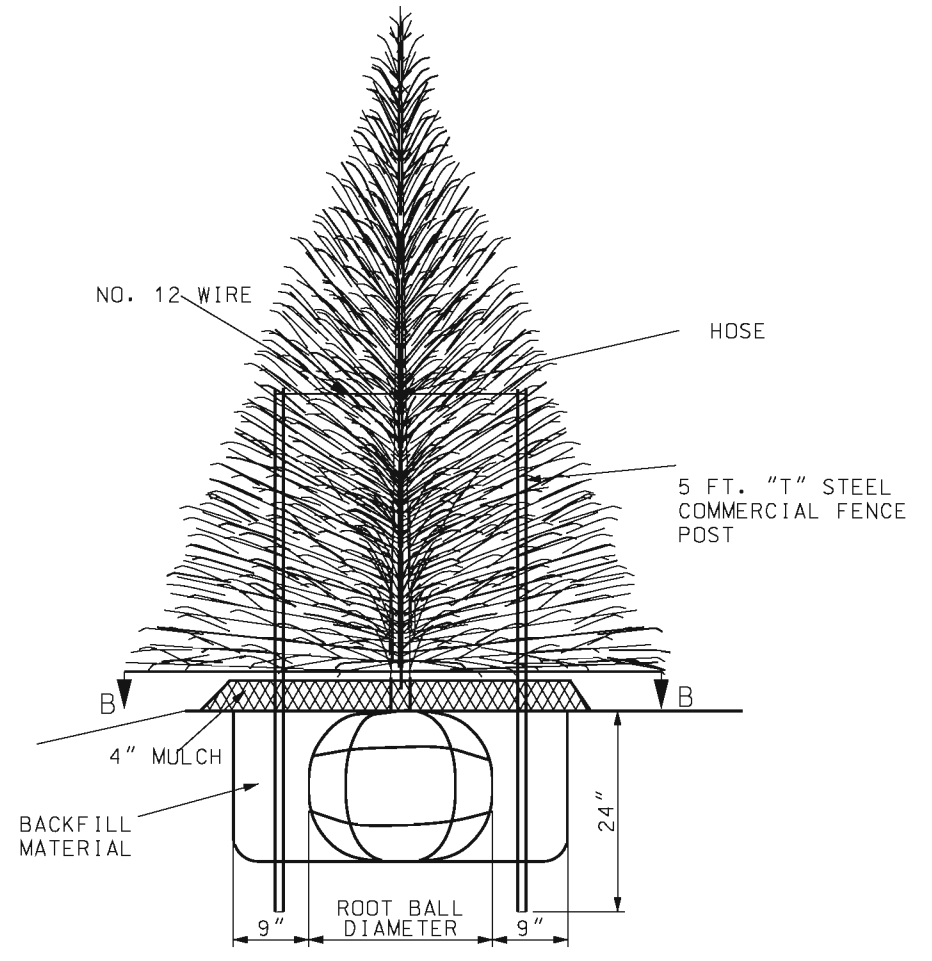

METHOD OF SUPPORTING EVERGREEN TREES  
3' OR MORE IN HEIGHT

NOTES:

- TREE WRAP SHALL BE INSTALLED BEFORE BRACING.
- BRACE SHALL BE NAILED SECURELY TO POST AND BRACE BLOCK.
- BANDING SHALL BE DONE WITH A COMMERCIAL BANDING MACHINE.

GENERAL NOTE:

ALL NUMBER MEASUREMENTS ARE NOMINAL.

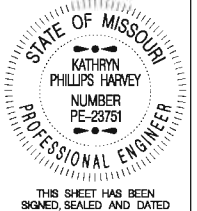
 <b>MISSOURI HIGHWAYS AND TRANSPORTATION COMMISSION</b> 105 WEST CAPITOL JEFFERSON CITY, MO 65102 1-888-ASK-MODOT (1-888-275-6636)	
	<p><b>TYPICAL PLANTING ILLUSTRATIONS</b> METHOD OF SUPPORT</p>
DATE EFFECTIVE: 07/01/2004 DATE PREPARED: 8/26/2009	<p><b>808.00</b></p>
SHEET NO. 1 OF 3	

IF A SEAL IS PRESENT ON THIS SHEET IT HAS BEEN ELECTRONICALLY SEALED AND DATED.

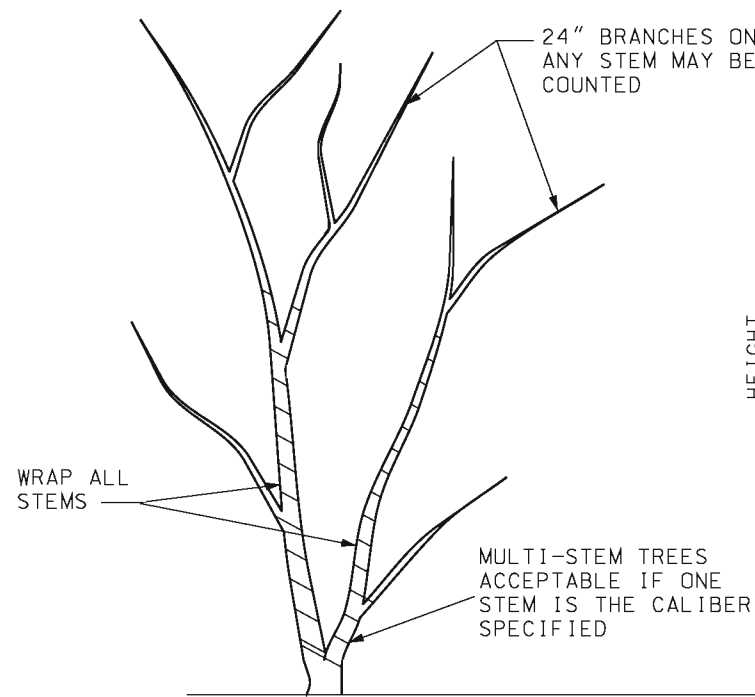

MEASUREMENT OF SMALL TREES

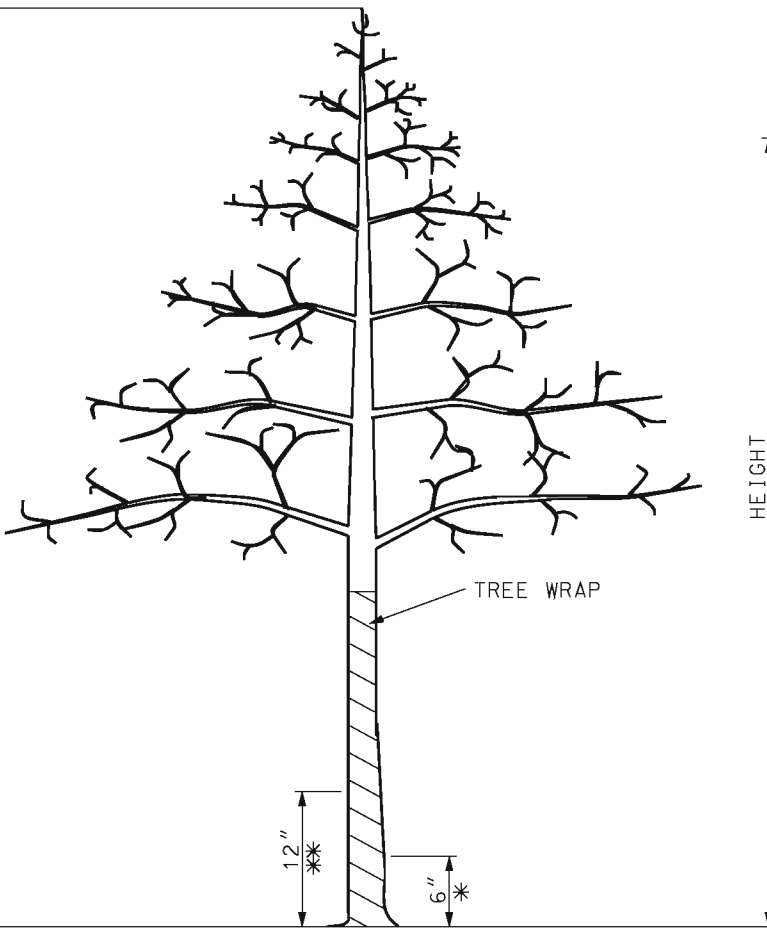
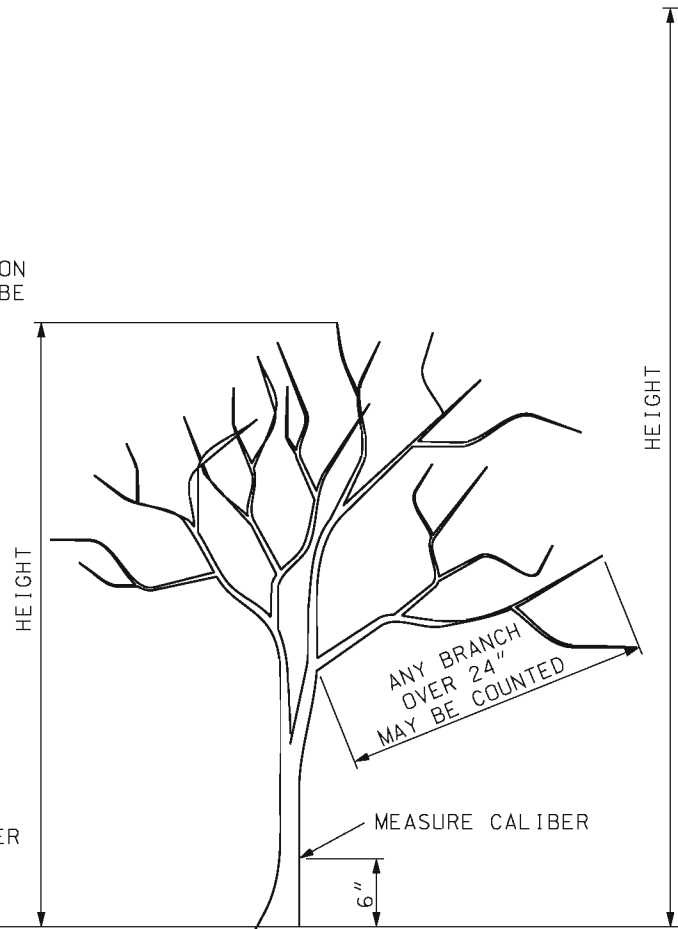

\* MEASURE CALIBER FOR TREES 4" OR LESS.  
 \*\* MEASURE CALIBER FOR TREES MORE THAN 4".

MEASUREMENT OF LARGE TREES

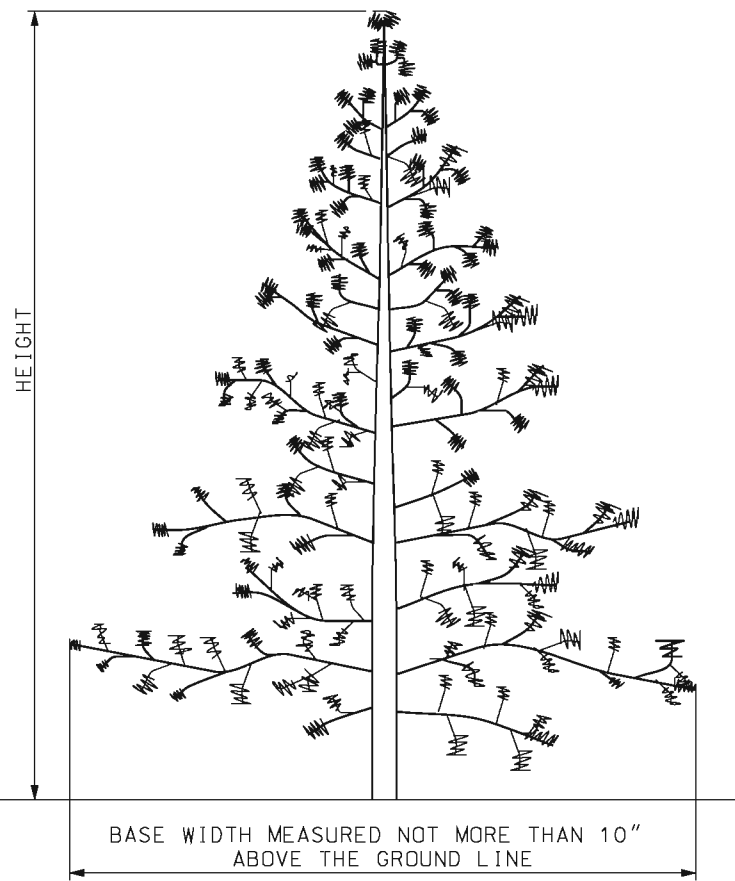

MEASUREMENT OF EVERGREEN TREES

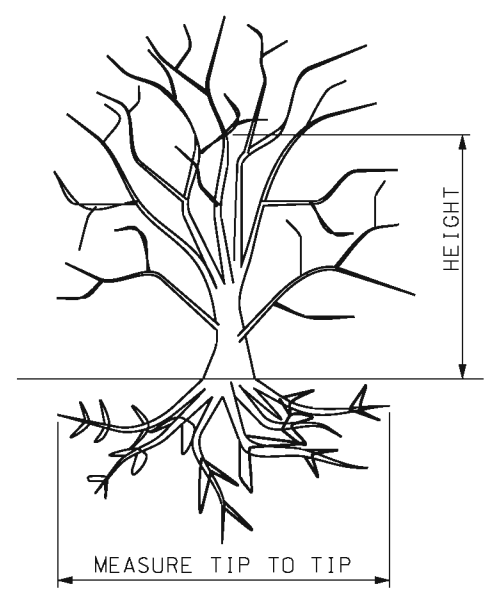

MEASUREMENT OF DECIDUOUS SHRUBS

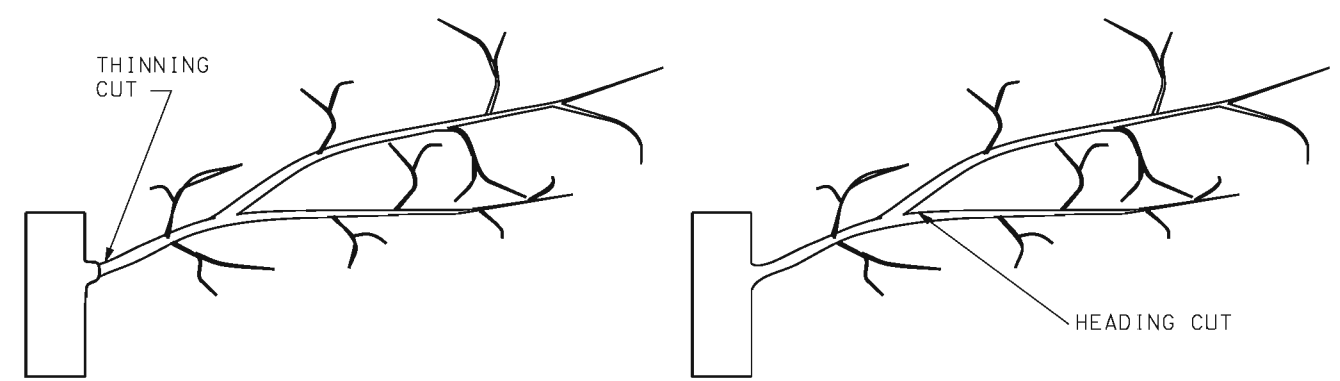

PRUNING CUTS

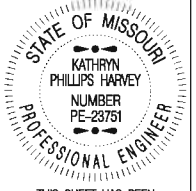
 <b>MISSOURI HIGHWAYS AND TRANSPORTATION COMMISSION</b> 105 WEST CAPITOL JEFFERSON CITY, MO 65102 1-888-ASK-MODOT (1-888-275-6636)	
	<b>TYPICAL PLANTING ILLUSTRATIONS</b> MEASUREMENT AND PRUNING CUTS
DATE EFFECTIVE: 07/01/2004 DATE PREPARED: 8/26/2009	<b>808.00</b>
SHEET NO. 2 OF 3	

IF A SEAL IS PRESENT ON THIS SHEET IT HAS BEEN ELECTRONICALLY SEALED AND DATED.

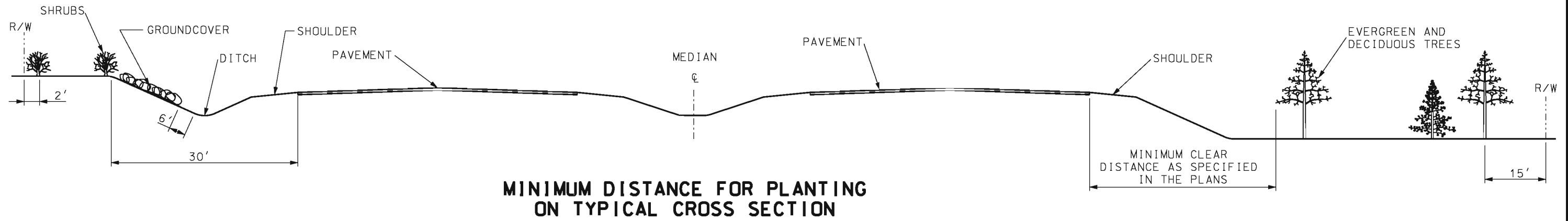

**MINIMUM DISTANCE FOR PLANTING ON TYPICAL CROSS SECTION**

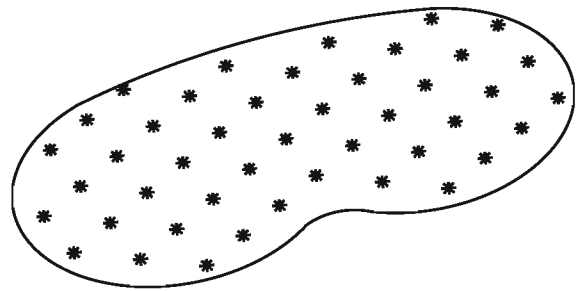

LOCATION OF SHRUBS IN A TYPICAL PLANT BED

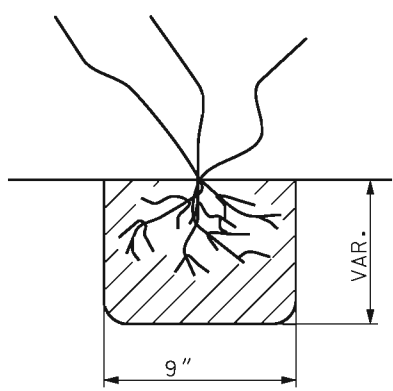

VINES AND SEEDLINGS

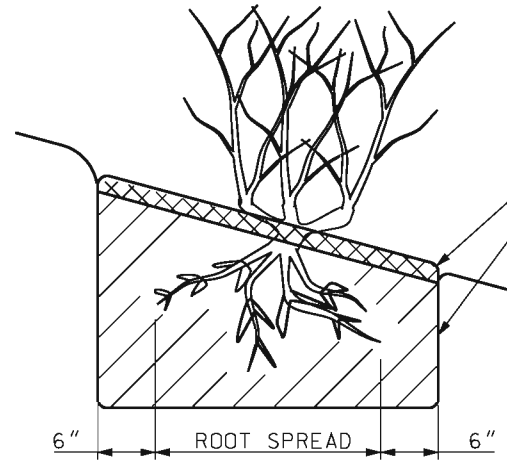

DECIDUOUS SHRUB SLOPE PLANTING

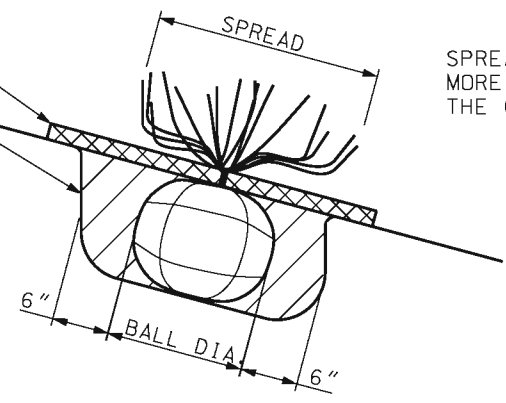

EVERGREEN SHRUB SLOPE PLANTING

SPREAD MEASURED NO MORE THAN 10" ABOVE THE GROUND LINE.

	<b>MISSOURI HIGHWAYS AND TRANSPORTATION COMMISSION</b> 105 WEST CAPITOL JEFFERSON CITY, MO 65102 1-888-ASK-MODOT (1-888-275-6636)	
		<p><b>TYPICAL PLANTING ILLUSTRATIONS</b></p> <p>LOCATION AND SLOPE PLANTING</p>
DATE EFFECTIVE: 07/01/2004 DATE PREPARED: 8/26/2009	<p><b>808.00</b></p>	SHEET NO. 3 OF 3

IF A SEAL IS PRESENT ON THIS SHEET IT HAS BEEN ELECTRONICALLY SEALED AND DATED.