



HMA - Consensus



HMA

Updates

- **2024 - 2025 No updates**
- **2023 – Updates:**
 - AASHTO T176: Thermometer types per AASHTO 339M to use.
 - ASTM E1 Mercury Thermometer
 - ASTM E2877 Digital metal stem thermometer
 - ASTM E230/E230M Thermocouple Thermometer (Type J or K, Class 1, Type T any class)
 - Dial Gauge metal stem (Bi-metal) Thermometer
 - AASHTO T304: Thermometer types per AASHTO 339M to use.
 - ASTM E1 Mercury Thermometer
 - ASTM E2877 Digital metal stem thermometer
 - ASTM E230/E230M Thermocouple Thermometer (Type T special)
 - IEC 60584 Thermocouple thermometer (Type T, Class1)
- 2022 – Entire Manual has been updated. No method changes.

COURSE CONTENT

HMA AGGREGATE CONSENSUS TESTS

Module 1		Consensus Sampling and QC/QA
Module 2	AASHTO T 176	Plastic Fines in Graded Aggregate and Soils by Use of the Sand Equivalent Test
Module 3	AASHTO T 304	Uncompacted Void Content of Fine Aggregate
Module 4	ASTM 5821	Determining the Percentage of Fractured Particles in Coarse Aggregate

MODULE 1

HMA AGGREGATE CONSENSUS TESTS TRAINING/CERTIFICATION COURSE

HMA Consensus General

APPLICATION OF TEST RESULTS

Revision 04/04/2022

1

SUPERPAVE

- A SHRP product (1993).
- SuperiorPERforming asphalt PAVements.
- New way of specifying binders and aggregates, and a new mix design method.
- Tied to pavement performance.

2

2

PERFORMANCE BEHAVIOR-Major

- **Permanent Distortion** - this course.
 - Rutting
 - Shoving
 - Corrugations
- Fatigue cracking
- Cold temperature cracking
- **Moisture Sensitivity (stripping)** - this course.

3

3

Permanent Deformation
Rutting

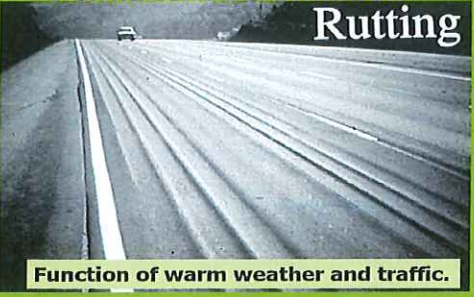

Function of warm weather and traffic.

And a function of *particle shape* of the *fine and coarse aggregates*.

4

4

MOISTURE DAMAGE (STRIPPING)



Figure 2: HMA samples with no moisture damage (left) and moisture damage (right). Notice the amount of uncoated aggregate on the damaged sample.

5

5

QC/QA
What is it?

QC...Contractor provides control of the process.

QA...Owner provides assurance that control is working.

6

6

QC/QA

Quality Control:

- Aggregate Producer
- Paving Contractor

Quality Assurance:

- Owner (MoDOT)

7

7

SUPERPAVE MIXTURE NAMES

"SPnnnyzz"

SP= Superpave

nnn=nominal max size

- 048= 4.75 mm (#4)
- 095= 9.5 mm (3/8 in)
- 125=12.5 mm (1/2 in)
- 190=19.0 mm (3/4 in)
- 250=25.0 mm (1 in)

8

8

SUPERPAVE MIXTURE NAMES

y = mixture design (ESAL's)

- F= < 300,000
- E= 300,000 to < 3,000,000
- C= 3,000,000 to < 30,000,000
- B= ≥ 30,000,000

zz = special designations: examples

- LP= Limestone Porphyry
- SM= Stone Mastic Asphalt
- SMR= SM Rural
- NC= Non-Carbonate
- LG= Lower Gyration

9

9

SUPERPAVE "NOMINAL MAXIMUM SIZE"

1. Look at the combined gradation of the hot mix. Identify the largest sieve that accumulatively retains 10% or more.
2. Move up one sieve larger - that is the "nominal maximum size" (NMS).
3. *The "maximum size" is one size larger than the NMS.*

10

10

USE OF ESAL'S IN MATERIAL SELECTION

- *Level of aggregate required quality is tied to level of traffic*; for instance, the greater the design traffic, the more angular and cleaner the aggregate must be.
- The choice of PG binder grade is tied to traffic level; for instance, the greater the design traffic, the more rut resistant the binder must be.

11

11

MIX EXAMPLE

- SP250B =**
- Superpave
 - 25 mm NMS (1 in.)
 - "B" traffic level ($\geq 30,000,000$ ESALs)

12

12

ESAL's

- **ESAL** is the acronym for **E**quivalent **S**ingle **A**xle **L**oad.
- The reference axle load is **18,000 – lb.** single axle with dual tires. By convention, an 18,000-pound single axle is 1.00 ESAL.
- **ESAL** – is the relationship between axle weight and pavement damage.



13

13

ESAL's

- Conversion of damage from a given **axle load** to an equivalent number of passes of an 18,000 lb. load on a single axle (equal damage).
- For instance, one pass of a 22,000 lb. single axle is equivalent in damage to 2.2 passes of an 18,000 lb. single axle load.

14

14

ESAL Comparison

80 kN
18,000 lb. 100 kN
22,000 lb. 44 kN
10,000 lb.

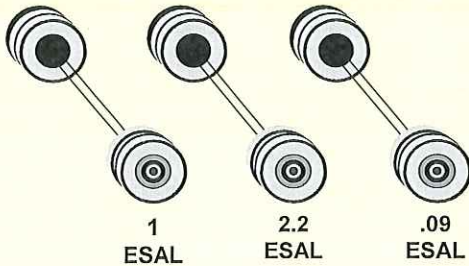

15

15

ESAL's

Another way...

- Conversion of a given **vehicle** to an equivalent number of passes of an 18,000 lb load on a single axle (equal damage).
- For instance, one pass of a certain 6 tire truck is equivalent in damage to 0.49 pass of an 18,000 lb single axle load.

16

16

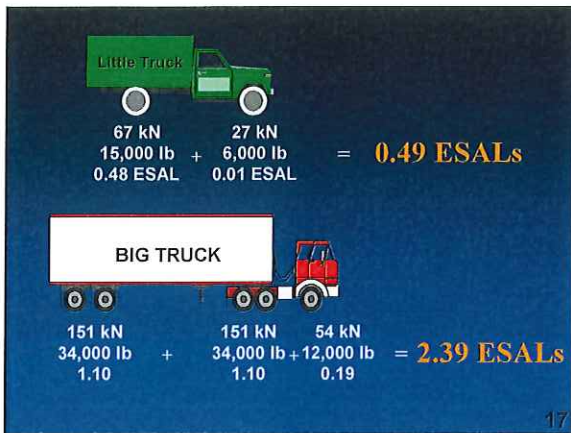

17

17

AGGREGATE INSPECTION

- **QC and QA** perform tests, compare results to each other and to:
 - Standard Specifications (sec 403)
 - Job Special Provisions
 - Engineering Policy Guide (EPG) guidelines

18

18

AGGREGATE ACCEPTANCE

- Emphasis on end-result testing to allow quarries more flexibility during production.
- Aggregate acceptance is at the mixing facility.
- **Usage:** MoDOT still sampling/testing ledges (initial approval of ledges & annual source approval) at the quarry.
- Still will visit quarries to assure that proper ledges are being used.

19

19

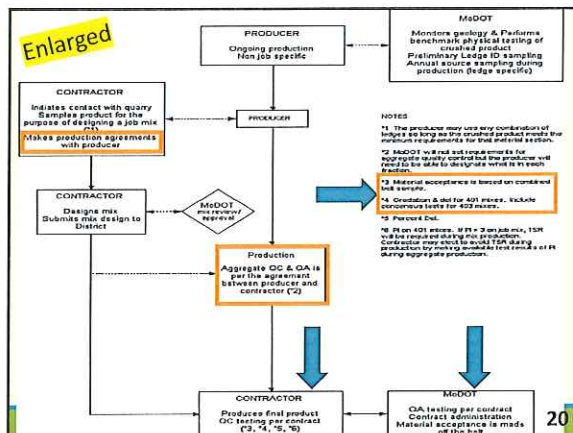

20

403 REQUIRED TESTING: Aggregate

- Gradation
- **Consensus tests:** FAA, SE, F&E, and CAA
- Deleterious Materials
- RAP

FAA = Fine Angular Aggregate
CAA = Coarse Angular Aggregate
F&E = Flat and Elongated
SE = Sand Equivalent

21

21

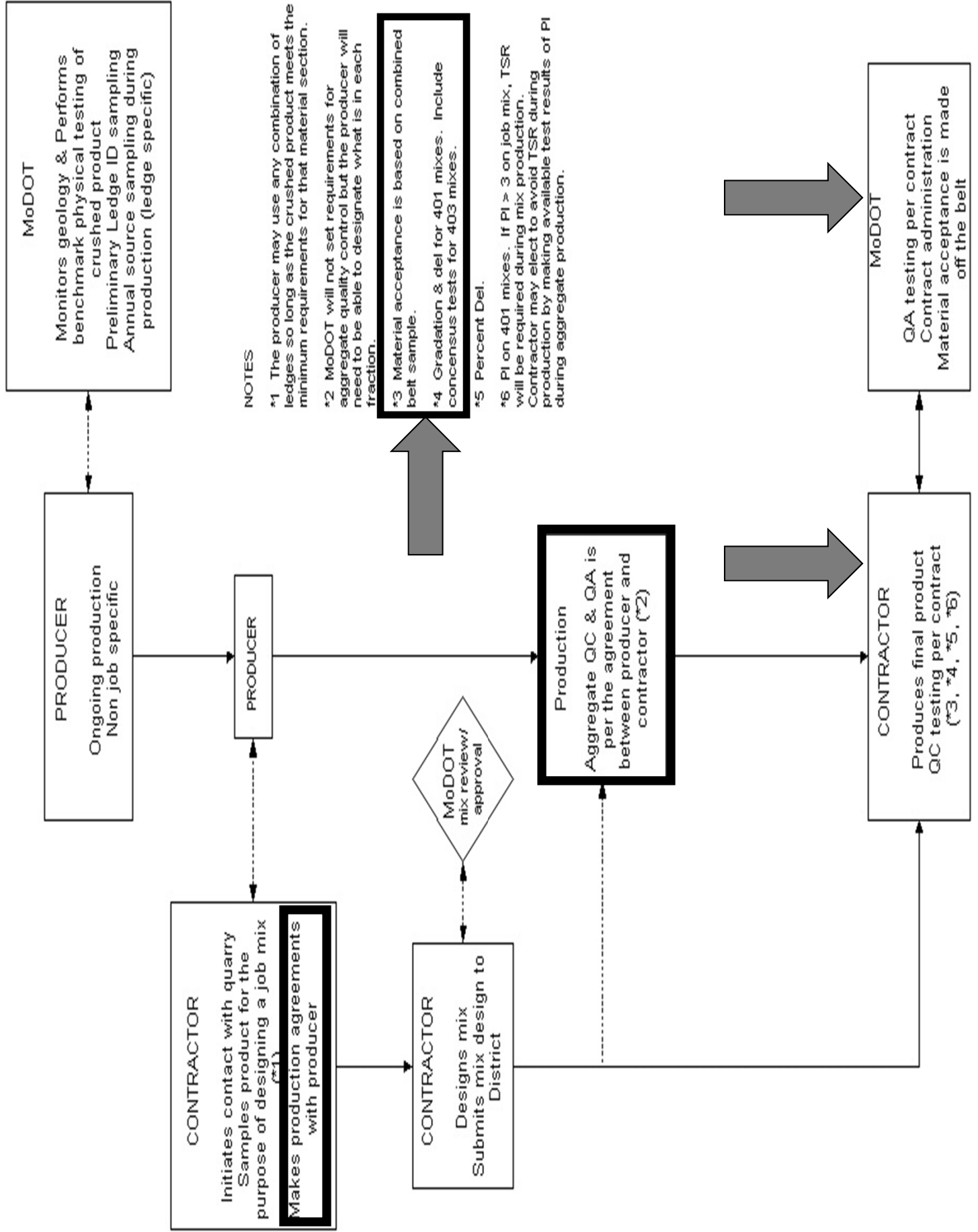

SAMPLING: Aggregate Consensus

- Drum plant—cold feed belt
- Batch plant—cold feed belt
- Cannot use ignition oven residue

- Do not put additional filler (lime, etc) into the sample.

22

22

SAMPLING Drum Plant Methods

- Off the combined cold feed belt

- Diverter

23

23

COLD FEED BLENDED AGGREGATE



24

24

SAMPLING Drum Plant Cold Feed Belt



25

25

Drum Mix Plant Diverter

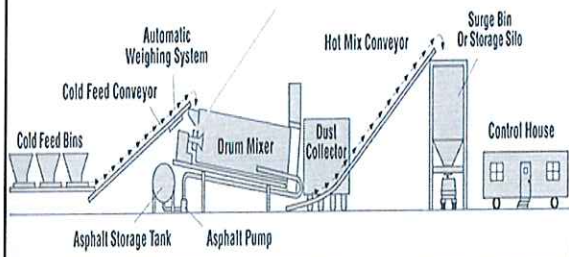

26

26

DIVERTER CHUTE



27

27

SPLITTING METHODS

- Mechanical splitter
 - Riffle splitter
 - "Quartermaster"

- Quartering of pile

28

28

Fine Aggregate Riffle Splitter



29

29

Coarse Aggregate Riffle Splitter



30

30

Coarse Aggregate Riffle Splitter



31

31

Quartermaster



32

32

SPLITTING



33

33

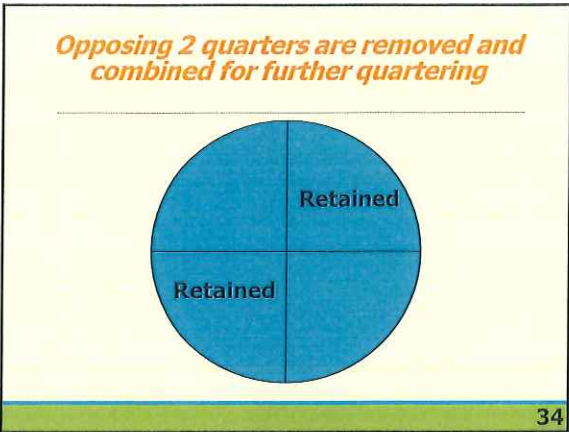

34

Example Consensus Tests Sampling Scenario

- Sampling for consensus tests material; (QC = 1 per 10,000 tons) at the same time sampling for gradation and deleterious materials (QC = 1 per 2 sublots).
- Assumptions:**
 - SP125
 - Drum Plant

35

35

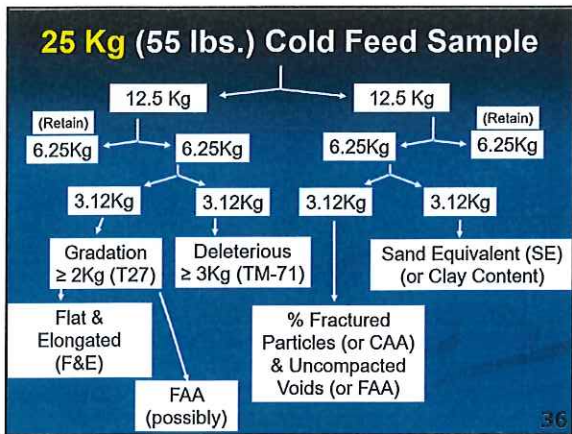

36

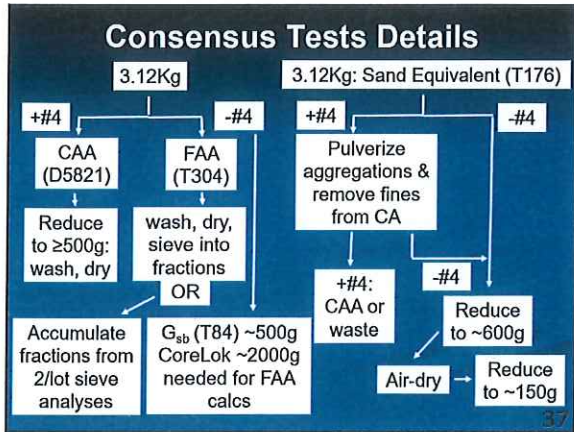

37

QC AGGREGATE CONSENSUS SAMPLING/TESTING

- **Independent:**
 - 1 per 10,000 tons mix (at least 1 per project per mix-however, could represent several mixes if using all the same fractions).
- **Retained split:**
 - 1/2 of each QC sample will be properly tagged and retained until QA has accepted the QC-QA comparison.
 - This sample is to be the 1/2 part of the last split when obtaining the proper testing size.

38

QA AGGREGATE CONSENSUS SAMPLING/TESTING

Independent:

- 1 per project minimum

QC retained split:

- 1 per project minimum

Small Quantity Projects (<4000 tons):

- Comparison not necessary

39

AGGREGATE

Acceptance:

- *Be within tolerance of JMF values.*
- Compare "favorably" with QA results.

40

40

COMPARISON TO SPECIFICATIONS: Field Tolerances

Consensus tests:

- $FAA_{spec} - 2\%$
- $CAA_{spec} - 5\%$
- $SE_{spec} - 5\%$
- $F\&E_{spec} + 2\%$

41

41

MoDOT MIXTURE TYPES

Design Levels	Design Traffic (ESALS)
F	< 300,000
E	300,000 to < 3,000,000
C	3,000,000 to < 30,000,000
B	≥ 30,000,000

42

42

SECTION 403 CONSENSUS REQUIREMENTS on blended aggregate (5:1)				
Design Level	CAA %	FAA %	SE %	F&E* %
F	55/none	---	40	10
E	75/none	40	40	10
C	95/90	45	45	10
B	100/100	45	50	10

* SMA: ≤ 20% @ 3:1 and ≤ 5% @ 5:1

43

CONSENSUS REQUIREMENTS

- CAA, FAA, and SE are minimums
F&E are maximums.

44

FIELD TOLERANCES Applied to 403 Spec Example: C mix

Design Level	CAA % minimums	FAA % minimums	SE % minimums	F&E* % max
F	55/none	---	40	10
E	75/none	40	40	10
C	95/90	45	45	10
B	100/100	45	50	10

F&E: 10 + 2 = Max of 12%
SE: 45 - 5 = minimum of 40%
FAA: 45 - 2 = minimum of 43%
CAA: 95 - 5 = minimum of 90, 90 - 5 = 85 so...90/85 %

45

FIELD TOLERANCES
Example: C mix

- FAA result is 44 % -- *is this acceptable in the field?*

Spec minimum is 45%, but with field tolerance applied, the minimum acceptable is
 $45 - 2 = 43\%$

So, yes 44% *is acceptable*

46

46

FIELD TOLERANCES
Example: C mix

- Fractured Face Count result= 92% single-faced and 87% multiple-faced. Is this acceptable?
- Spec minimums are 95/90, but with field tolerance applied, the minimum acceptable tolerances are $95-5=90\%$ and $90-5=85\%$,
so:
 - 92/87 is greater than 90/85,
so...acceptable

47

47

AGGREGATE

Acceptance:

- Be within tolerance of JMF values.
- *Compare "favorably" with QA results (close enough).*

48

48

COMPARING QA TO QC (QC Retained Sample) *Close Enough?*

Consensus Tests:

- CAA: QC \pm 5%
- FAA: QC \pm 2%
- SE: QC \pm 8%
- T&E: QC \pm 1%

49

49

EXAMPLE COMPARISON Test Results

- FAA: QC = 46%, QA = 48%
- Is there "favorable comparison"?
 - *Yes, must be within 2, and they are*

50

50

What if QA and QC Don't Compare Favorably?

- Check math
- Check procedures
- Check splitting method
- Re-test
- Still not comparing?
 - Are all other tests within-spec?
 - If so, perhaps accept with a deduct

51

51

REPORTING OF TEST RESULTS

All QC test results will be maintained in a bound booklet format in the lab and always made available to the QA inspector.

52

52

REPORTING OF TEST RESULTS

- The sample retained will be labeled with the following information:
 - Time and date of sample.
 - Product specification number ($\frac{3}{4}$ " $\frac{3}{8}$ " $\frac{3}{8}$ ", etc.).
 - Type of sample (belt, bin, stockpile, etc.).
 - Copy of QC test results.
 - Name of sampler/tester.

53

53

QC/QA Functions at the Hot Mix Facility

AGGREGATE

FUNCTION	LOCATION	FREQUENCY
Aggregate Gradation: 3 sieves: 1 size smaller than NMS _{JMF} : Not to exceed 92.0% #8: Not to exceed 2.0% beyond master spec #200: Within master spec	Drum: Combined cold feed Batch: Hot bins Optional: T308 Residue	QC: 1 per 2 sublots QA: 1 per 4 sublots QA: QC retained: 1 per week
Consensus Tests: FAA _{spec} -2% CAA _{spec} -5% SE _{spec} -5% T&E _{spec} +2%	Drum: Combined cold feed Batch: Combined cold feed	QC: 1 per 10,000 tons (min. 1 per project per mix type) QA: 1 per project QA: QC retained: 1 per project

54

QC/QA Functions at the Hot Mix Facility

Aggregate

FUNCTION	LOCATION	FREQUENCY
Aggregate:		
Aggregate gradation 3 sieves: 1 size smaller than NMS_{JMF} : not to exceed 92.0% #8: not to exceed 2.0% beyond master spec #200: within master spec	Drum: Combined cold feed Batch: Hot bins Optional: T308 Residue	QC: 1 per 2 sublots QA: 1 per 4 sublots QA: QC retained: 1 per week
Consensus tests: FAA_{spec} -2% CAA_{spec} -5% SE_{spec} -5% $T\&E_{spec}$ +2%	Drum: Combined cold feed Batch: Combined cold feed	QC: 1 per 10,000 tons (min. 1 per project per mix type) QA: 1 per project QA: QC retained: 1 per project

MODULE 2

AASHTO T176

PLASTIC FINES IN GRADED AGGREGATES AND SOILS BY USE OF THE SAND EQUIVALENT TEST

Sand Equivalent

AASHTO T 176

**Plastic Fines in
Graded Aggregates and Soils
By Use of the Sand Equivalent Test**

Revision 08/30/2022

1

OUTLINE

- Scope
- Significance and Use
- Equipment
- Sampling & Size Reduction
- Sample & Specimen Preparation
- Procedure
- Calculations
- Reporting
- Comparing to Specification
- Common Errors

2

2

SCOPE

This test is intended to serve as a rapid test to show the relative proportions of fine dust or claylike material in soils or graded aggregates.

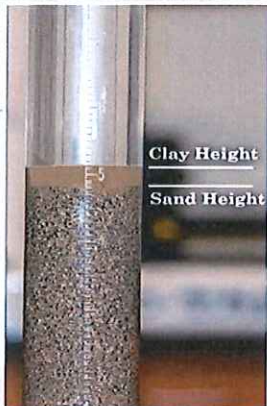

Scope

3

3

SIGNIFICANCE AND USE

"This test method is used to determine the proportion of detrimental fines in the portion passing the No. 4 sieve of soils or graded aggregate" (AASHTO T176).

Significance and Use

4

4

EQUIPMENT

- Sieve 4.75mm (No. 4)
- Sample splitter
- Straight-edge or spatula
- Tinned measure (3 oz.)
- Plastic graduated cylinder
- Rubber stopper
- Wide-mouth funnel



Equipment

5

5

- Calcium chloride concentrated stock flocculating solution
- Calcium chloride flocculating working solution
- Irrigation tube
- Timer
- Weighted foot assembly
- Oven capable of maintaining $230 \pm 9^\circ\text{F}$ ($110 \pm 5^\circ\text{C}$)

Equipment

6

6

Working Calcium Chloride Solution

- Dilute 85 ± 5 ml with water to obtain 1 gal. total. Mix thoroughly.
- Use distilled or demineralized water.
 - Discard after 30 days
 - Maintain at 72 ± 5 °F (22 ± 3 °C)
 - Keep out of sunlight

Equipment

7

7

NOTE!

The mechanical shaker is the equipment of choice for this test method.

Any disputes of test results will first rely on the result performed on the mechanical shaker.

Equipment

8

8

Reference Method



Mechanical Shaker – (powered)

- 175 ± 2 cycles per min.
- Throw of 8.00 ± 0.04 " (203.2 ± 1.0 mm)
- Run for **45 ± 1 Seconds**
- Used for dispute resolutions.

Equipment

9

9

Hand Shaking

- Insert stopper and shake cylinder 90 cycles in 30 sec.
- Throw of $9 \pm 1''$ (229 ± 25 mm)



Equipment

10

10

Manually Operated Shaker

- Oscillating motion of 100 complete cycles in 45 ± 5 seconds.
- A hand-assisted half stroke length of $5.0 \pm 0.2''$ (127 ± 5 mm).
- Run for 100 strokes.

If used, the rate info must be stated in QC plan. Not considered acceptable for dispute resolution.

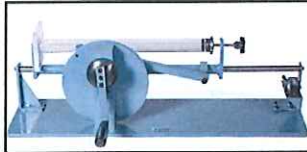

Equipment

11

11

More information on equipment can be found in the appendix.



Equipment

12

12

TEMPERATURE CONTROL

- The temperature of the working solution should be maintained at $22 \pm 3^{\circ}\text{C}$ ($72 \pm 5^{\circ}\text{F}$) during the performance of this test.
- If field conditions prevent the maintenance of the temperature range, frequent reference samples should be submitted to a laboratory where proper temperature control is possible.

Equipment 13

13

New slide for 2023

THERMOMETER

- The thermometer used for monitoring the temperature of the oven, or for measuring the temperature of materials shall meet the requirements of ASHTO M339M/M339 with a temperature range of at least 194 to 266°F (90 to 130°C), and an accuracy of $\pm 2.25^{\circ}\text{F}$ ($\pm 1.25^{\circ}\text{C}$).

Equipment 14

14

New slide for 2023

THERMOMETER

- Thermometers to use for this test:
 - ASTM E1 Mercury Thermometer
 - ASTM E2330/E230M thermocouple, Type J or K, class or K Special Class, Type T any Class
 - IEC 60584 thermocouple thermometer, Type J or K, class 1, Type T any class
 - Dial gauge metal stem (bi-metal) Thermometer.

Equipment 15

15

SAMPLING AND SIZE REDUCTION

SAMPLING SUMMARY

- Obtain a sample of the material to be tested in accordance with AASHTO R90.
 - Cold feed belt.
- Reduce the sample according to AASHTO R76.
- The sample shall be 1,000 to 1500g of material passing #4 sieve.
- Split or quarter the -4 material to yield 500 – 750g.

16

16

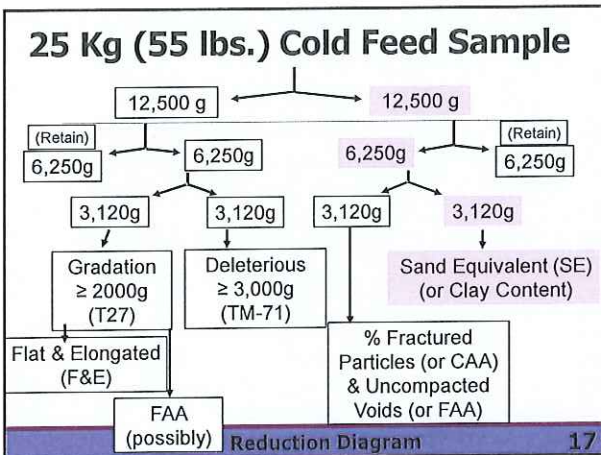

17

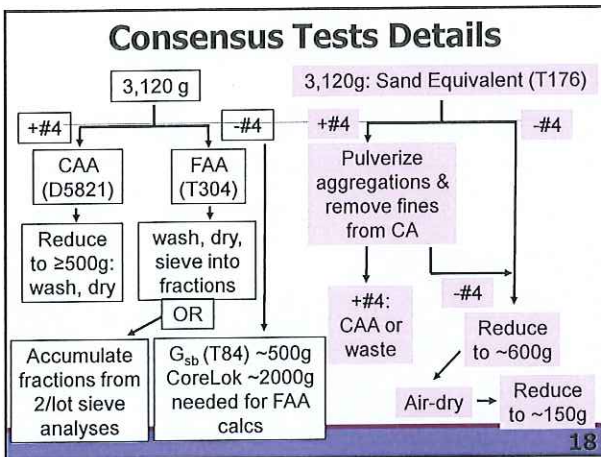

18

Split Over #4 Sieve

Plus #4: Coarse Aggregate (CA):

- CAA
- F&E



Minus #4: Fine Aggregate (FA):

- FAA

• SE

Sampling and Size Reduction 19

19

SAMPLE PREPARATION

- Reduce sample size. ~ 3,120 grams
- Sieve over a #4 (4.75mm) sieve.
- Any clumps or dust should be broken apart; the (- #4) should be included with the passing material.
- Remove coatings on (+#4) material (by rubbing it between the hands-ASTM)- include with the passing material.
- At every step, be sure to capture all the dust.
- Moistening is allowed.

Sample Preparation 20

20

SIEVE THE SAMPLE #4 SIEVE

Sieve the field sample over #4 Sieve.



Use -4 Material for testing T176
Need ~ 1,000 to 1500g

Sample Preparation 21

21

- Split or quarter the 1,000 to 1500g of -4 material to yield ~ 500 – 750g.



Sample Preparation 22

22

SAMPLE & SPECIMENT PREPARATION

- 1) A: Dried
 - Oven dried (reference method)
 - **Air dried**
- 2) B: Pre-wet

Note: Non-oven (air) dried SE results may be lower (oven-drying may lower the clay activity, thus SE will calculate higher). Thus, if non-dried test result is lower than the minimum allowed, a new sample may need to be tested after oven drying, which may raise SE.

Sample Preparation 23

23

Preparation #1 **Air dried**

- Split or quarter enough material from the portion passing #4 sieve to fill a 3oz tin measure so it is slightly rounded above the brim.
- While filling the measure, tap the bottom edge of the tin on the worktable to consolidate.
- Allow the maximum amount to be placed in the tin.
- Strike off the tin with a spatula or straightedge to level the top with the tin can.

Sample Preparation 24

24

PROCEDURE

- Obtain the 3oz tin measure of -4 material and dry the test sample to a constant mass at $230 \pm 9^\circ\text{F}$ ($110 \pm 5^\circ\text{C}$) and cool to room temperature before testing.

3oz tin holds ~120 to 150 g of sample.



Procedure

25

25

- Start the siphon by forcing air into the top of the solution bottle through the bent copper, glass, or stainless-steel blow tube while the pinch clamp is open.
- Siphon apparatus is now ready for use.

Procedure

26

26

- **Siphon 4.0 ± 0.1 "** ($101.6 \pm 2.5\text{mm}$) of solution into graduated cylinder.

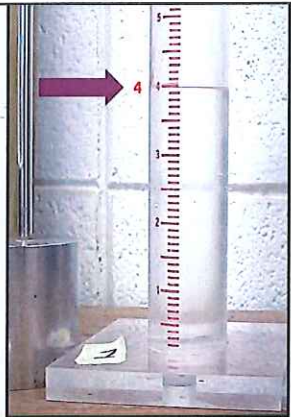

Procedure

27

27

■ Using the wide-mouthed funnel, pour sample into cylinder incrementally, de-airing as you go.

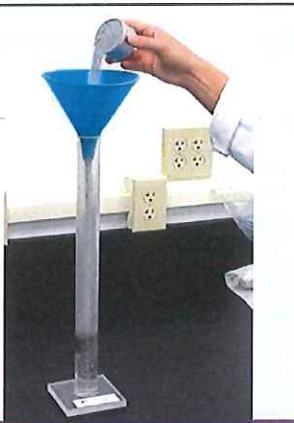

Procedure 28

28

■ Place the rubber stopper on the top.

■ Tap the bottom of the cylinder sharply with the heel of your hand several times (This is to release air bubbles and to promote thorough wetting of the material.)

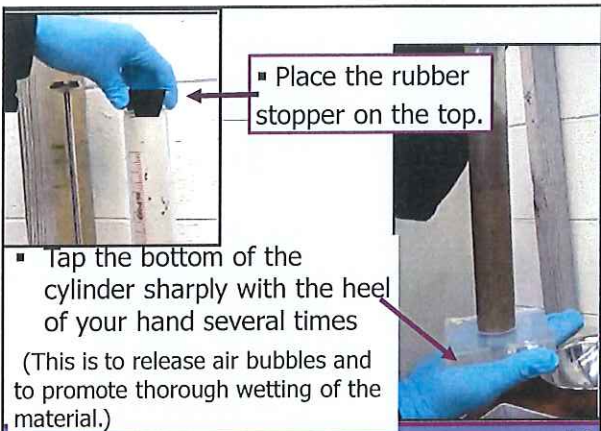

Procedure 29

29

■ Remove the stopper
 ■ Start timer
 ■ Leave sample undisturbed for 10 ± 1 min.
 ■ Place rubber stopper in cylinder and partially invert to loosen material.
 ■ After loosening material, place the cylinder in the shaker and shake for prescribed amount of time for the shaker being used.



Mechanical Shaker is The reference method

Procedure 30

30

- Set cylinder upright and remove rubber stopper.
- Insert irrigation tube, rinsing the walls of the cylinder as the irrigator is lowered.
 - The container of solution should be maintained 36" to 46" above the cylinder bottom.



Procedure

31

31

- Force the irrigator through the material to the bottom of the cylinder by applying a gentle stabbing and twisting action while solution flows from the irrigator tube.
- Continue this action while flushing the fines upward until the cylinder is filled to the 15" (381 mm) level.

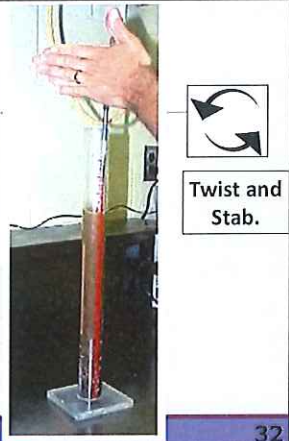

Procedure

32

32

- Allow cylinder to remain undisturbed for 20 min. \pm 15 sec.
- Determine final level by judging the bottom of the meniscus to be between the top two graduations not to exceed the 15" (381mm) mark.



Procedure

33

33

- Read and record the level of the top of the clay suspension, **always rounding up.** This is the "Clay Reading".

Example: If reading is between 36 & 37, call it 37.

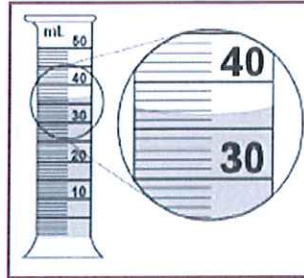

Procedure

34

34

- If unable to get a clear reading, at the end of 20min, allow sample to stand until a clay reading can be obtained, record the total sedimentation time.

- If time is more than 30 min. Rerun the test using 3 individual samples of the same material. Record the result of the sample with the shortest sedimentation period only.

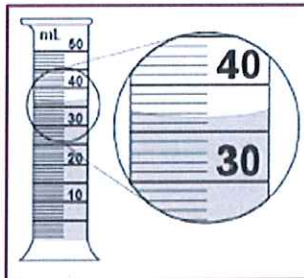

Procedure

35

35

SAND READING

- Gently lower the weighted foot assembly into the cylinder taking care not to touch the sides of the cylinder until it rests on the settled material.
- As the weighted foot assembly comes to rest on the sand, tip the assembly toward the graduations until the indicator touches the inside of the cylinder.



Procedure

36

36

SAND READING

- Subtract 10" (254mm) from level indicated by the extreme top edge of the indicator and record this value as the "Sand Reading". **Always round up.**



Procedure

37

37

Insert wt. foot

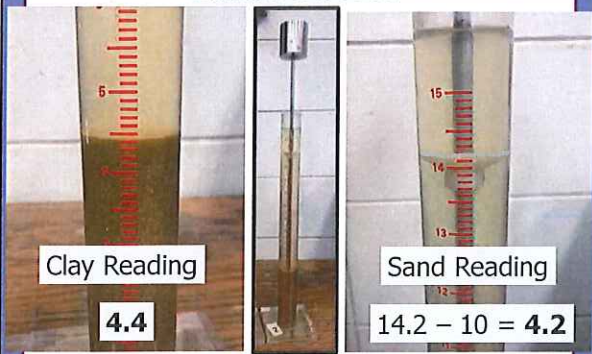

Procedure

38

38

CALCULATIONS & REPORTING

Calculate the sand equivalent (SE), Report to the nearest **0.1** using the following formula:

$$SE = \frac{\text{Sand Reading}}{\text{Clay Reading}} \times 100$$

Calculations & Reporting

39

39

Averaging SE Values

$$SE = \frac{42 + 44 + 41}{3} = 42.3$$

Readings: 41.2, 43.8, 40.9
 Round up to whole numbers: 42, 44, 41

Calculations & Reporting 40

40

Data Sheet – “Sand” Equivalent

Clay Reading	CR	7.0 in
Sand Reading **	SR	3.7 in
Sand Equivalent = (SR / CR) * 100		

** Don't forget to subtract 10" for the length of the indicator foot before recording the sand reading.
 Ex: 13.7 – 10.0 = 3.7 in.

Calculations & Reporting 41

41

Data Sheet – “Sand” Equivalent

Clay Reading	CR	7.0 in
Sand Reading **	SR	3.7 in
Sand Equivalent = (SR / CR) * 100		53 %

$$SE = [3.7 / 7.0] \times 100 = 52.9\% = 53\%$$

Calculations & Reporting 42

42

REPORTING

- When **reporting** the SE value, **always round up** to the **next higher whole number**.

In our example, 52.9 → "53"

Other examples: 52.1 = 53
 52.5 = 53

43

Comparing to Specification

44

SECTION 403 CONSENSUS REQUIREMENTS on Blended Aggregate (5:1)

Design Level	CAA% Minimum	FAA% Minimum	SE% Minimum	F&E*% Max
F	55/none	---	40	10
E	75/none	40	40	10
C	95/90	45	45	10
B	100/100	45	50	10

* SMA: ≤ 20% @ 3:1 and ≤ 5% @ 5:1

45

Comparing to 403 Specification With Field Tolerance
During Mix Production
"C" Traffic Level

Spec with field tolerance: $45 - 5 = 40$ minimum.

53 is greater than 40: is "Acceptable"

46

46

Common Testing Errors

- Concentrated stock solution has a shelf-life notice with the material--old stuff gets used.
- Calcium chloride working solution not mixed properly.
- Calcium chloride solution not maintained properly. (Has a certain shelf life):
 - Used outside acceptable temperature range
 - Not checked for organic growth
 - Exposed to direct sunlight
 - Not discarded after 30 days
- New solution added to old solution.

47

47

Common Testing Errors

- Organic (slimy) growth not removed from tubing and working solution container.
- Improper sample preparation.
- Sample not shaken properly in graduated cylinder.
- Sample vibrated during sedimentation stage
Sample not irrigated properly.
- Irrigation tube holes clogged.
- Hose gets soft and sticks together.

48

48

Plastic Fines in Graded Aggregates and Soils by use of the Sand Equivalent Test: AASHTO T 176-17

Trial#	1	2	R
Preliminary Material Preparation (state these requirements):			
1. Split a cold-feed belt field sample over #4 sieve			
2. Clean fines from +#4 particles and include with -#4 material			
3. Split or quarter -#4 material to yield slightly more than four 85 ml tin measures of -#4 material (500 – 750 grams)			
4. The remainder of the test can be performed on material in one of the following moisture conditions: 1) Air-Dry 2) Pre-Wet 3) Oven-Dry			
Air-Dry Sample Preparation (perform these requirements):			
5. Split or quarter enough air-dry -#4 material to fill one tin measure slightly rounded above brim			
6. While filling, tap tin measure on hard surface to consolidate material			
7. Strike off the tin measure level full with spatula or straightedge			
Procedure:			
8. Siphon 4 ± 0.1 inches of working calcium chloride solution into plastic cylinder			
9. Pour prepared sample from tin measure into cylinder using funnel to avoid spillage			
10. Tap bottom of cylinder sharply on heel of hand several times to release air bubbles and promote thorough wetting of sample			
11. Allow wetted sample to stand undisturbed for 10 ± 1 minutes (state this requirement)			
12. Place stopper in cylinder and loosen material from bottom of cylinder by partial inversion & shaking			
<i>Shake the Cylinder: Choose and perform only one of the following methods</i>			
13. <u>Hand Method</u> : Holding stoppered cylinder in horizontal position, shake vigorously in a horizontal linear motion from end to end, 90 cycles (one cycle is a complete back and forth motion) in approximately 30 seconds, using throw of 9 ± 1 inch			
14. <u>Manual Shaker Method</u> : Secure stoppered cylinder in device; reset stroke counter to zero; generate left-right oscillation by pushing with fingertips against right-hand steel spring (only during leftward motion) with sufficient force so that the pointer continually aligns with stroke limit marker; continue for 100 strokes			

15. <u>Mechanical Shaker (Reference) Method</u> : Secure stoppered cylinder in device and shake for 45 ± 1 seconds			
16. Following shaking, set cylinder upright on work table and quickly remove stopper			
17. As quickly as possible once the stopper is removed, insert the irrigator tube into the cylinder, start the solution flowing, and rinse material from cylinder walls as irrigator is lowered			
18. Force irrigator through material to bottom of cylinder with gentle stabbing and twisting action while solution flows from tip, flushing fines into suspension			
19. Continue to flush as many fines from sand as possible until fluid level approaches the 15" mark			
20. Withdraw irrigator without shutting off the fluid flow such that the final fluid level (as indicated by the bottom of the meniscus) is 15"			
21. Allow cylinder & contents to stand undisturbed for 20 minutes ± 15 seconds (state this requirement)			
22. At conclusion of 20 minutes ± 15 seconds time period, obtain and record "Clay Reading" (CR). If between divisions, round up to next highest 0.1"			
23. Gently and slowly lower weighted foot assembly into cylinder until foot comes to rest on top of sand layer			
24. Slightly tip the assembly until plastic disk indicator touches the side of the cylinder, observe the reading at the extreme upper edge of the indicator, subtract 10.0", record result as "Sand Reading" (SR). If between divisions, round up to next highest 0.1"			
Calculations:			
25. Calculate Sand Equivalent using the following equation: $\text{Sand Equivalent} = \frac{\text{SR}}{\text{CR}} \times 100$ (calculate to nearest 0.1%; report to next highest whole %)			
PASS?			
FAIL?			

Proctor _____ Date _____

Reviewer _____ Date _____

MODULE 3

AASHTO T304

UNCOMPACTED VOID CONTENT OF FINE AGGREGATE

MoDOT SUPERPAVE QC/QA
TRAINING/CERTIFICATION COURSE

**FINE AGGREGATE ANGULARITY
AASHTO T 304**

**UNCOMPACTED VOID CONTENT
OF FINE AGGREGATE**

Revision 08/31/2022

1

- Scope
 - Significance and Use
 - Equipment
 - Sampling & Size Reduction
 - Sample & Specimen Preparation
 - Procedure
 - Calculations/Reporting
 - Comparing to Specification
 - Common Errors
 - Volume Measure Calibration
- 2

2

SCOPE

- Test determines the **loose uncompactd void content** of a sample of fine aggregate.
- When performed on an aggregate sample of a known standard grading (Method A), this measurement provides an indication of **particle shape**.

Scope 3

3

- The materials angularity, roundness or surface texture relative to other materials of the same standard grading is indicated by the percent of voids determined by this test.
- The Superpave Asphalt Mix Design Method sets minimum requirements for void content that vary depending on traffic loads.

Scope 4

4

There are 3 Methods:

Method A: Standard Graded Sample. Uses a standard fine aggregate grading that is obtained by combining individual sieve fractions from a typical fine aggregate sieve analysis.

Method B: Individual Size Fractions. Uses each of three fine aggregate size fractions (#8), (#16), (#30), and (#50). For this method, each size is tested separately.

Method C: As-received Grading. Uses the portion of fine aggregate finer than a (#4) sieve.

NOTE: This certification will only be covering Method A. See the appendix for more information.

Scope 5

5

MoDOT MIXTURE TYPES

Design Levels	Design Traffic (ESALS)
F	< 300,000
E	300,000 to < 3,000,000
C	3,000,000 to < 30,000,000
B	≥ 30,000,000

Scope 6

6

SECTION 304 CONSENSUS REQUIREMENTS on blended aggregate (5:1)				
Design Level	CAA% Min	FAA% Min	SE% Min	F&E*% Max
F	55/none	---	40	10
E	75/none	40	40	10
C	95/90	45	45	10
B	100/100	45	50	10

* SMA: ≤ 20% @ 3:1 and ≤ 5% @ 5:1

Scope 7

7

MORE ANGULAR FINE AGGREGATE

- Better interlocking (thus, greater stability)
- Higher VMA

But...

- Higher cost
- Less compactibility

Scope 8

8

TO INCREASE VMA:
Use a More Angular Sand

- More angular aggregate will provide more voids for a given gradation.
- Replace some natural sand with manufactured sand.

Scope 9

9

SIGNIFICANCE AND USE

- The purpose is to maximize shear strength in either bound or un-bound aggregate mixtures.
- Increased shear strength helps resist rutting.
- **There are 3 Methods A, B, and C.** This presentation will cover Method A. Methods B and C can be found in the appendix of this manual.

Significance and Use

10

10

- **Methods A** provides percent void content determined under standardized conditions that depend on the particle shape and texture of a fine aggregate.
- An increase in void content by these procedures indicates greater angularity, less sphericity, or rougher surface texture, or some combination of the three factors.
- A decrease in void content result is associated with more rounded, spherical, smooth-surfaced fine aggregate, or a combination of these factors.

Significance and Use

11

11

SUMMARY OF TEST METHOD

- **Using Method A ; a *standard gradation* is built.**
- The sample is allowed to free-fall from a funnel into a cylinder of a known volume.
- Using the bulk dry specific gravity of the sample (AASHTO T 84), the percent of void space in the cylinder is calculated.
- This value is known as the Fine Aggregate Angularity Value or FAA.

Significance and Use

12

12

TYPICAL TEST RESULTS

- Using Method, **A**:
 - Natural Sands – 35 to 43 percent
 - Crushed Products – 43 to 50 percent

Significance and Use

13

13

BLENDED AGGREGATES

- Possible for a low angularity material to be blended with a greater angularity material and meet the specification.
- The materials must be tested after blending.
- A calculated weighted average of separate materials may not give the same results as an actual test of the blend.

Significance and Use

14

14

INDIVIDUAL FRACTIONS

- Individual fractions may be tested for FAA as a check on process control, but acceptance is based on tests of the blended aggregates.

Significance and Use

15

15

EQUIPMENT

- Cylinder measuring approximately 39mm (1.56 inches) in diameter, 86mm (3.44 inches) deep with a capacity of approximately 100 ml. Calibrated when new and annually.
- Funnel and funnel stand conforming to Figure 2, AASHTO T 304.
- Glass plate for calibrating cylindrical measure.

Equipment

16

16

- Pan large enough to contain funnel stand and catch overflow of material.
- Metal spatula with a **straight-edge** on the tip and side approximately 100mm (4 inches) long and 20 mm (0.8 inches) wide.
- Balance accurate to 0.1 gram.
- Pans for batching and weighing.
- A thermometer for measuring the temperature of water shall meet AASHTO M339M/M339 with a temperature range of at least 16 to 26°C, with an accuracy of $\pm 0.5^\circ\text{C}$.

Equipment

17

17

TYPES OF THERMOMETERS:

New Slide for 2023

- ASTM E1 Mercury thermometers
- ASTM E2877 digital metal stem thermometer
- ASTM E230/E230M Thermocouple thermometer, Type T Special
- IEC 60584 Thermocouple thermometer, Type T, Class 1

Equipment

18

18

FINE AGGREGATE ANGULARITY (FAA)

[Fine Aggregate Particle Shape (FAPS)]



Equipment

19

19

Funnel

Fine aggregate sample

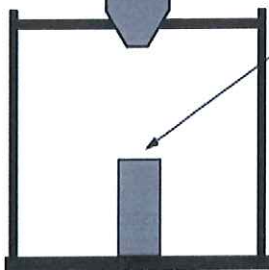

Cylinder of known volume (V)

Uncompact voids =

$$\frac{V - W/G_{sb}}{V} \times 100\%$$

Equipment

20

20

SAMPLING & SIZE REDUCTION

▪ The sample used for this test shall be obtained using AASHTO R90 and AASHTO R76, or from sieve analysis samples used for AASHTO T27, or from aggregate extracted from a bituminous specimen.

▪ For Methods A, the sample is washed over a No. 100 or No. 200 sieve in accordance with AASHTO T11 and then dried and sieved into separate size fractions according to AASHTO T27 procedures. Maintain the necessary size fractions obtained from one (or more) sieve analysis in a dry condition in separate containers for each size.

Sampling and Size Reduction

21

21

Consensus Test Material Must Be Sampled from the Cold Feed Belt

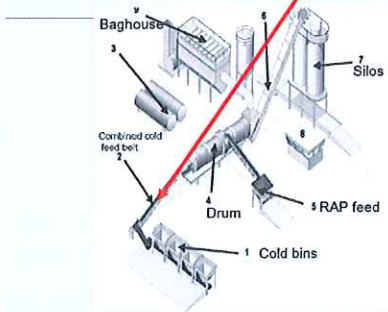

Sampling and Size Reduction

22

22

25 Kg (55 lbs.) Cold Feed Sample

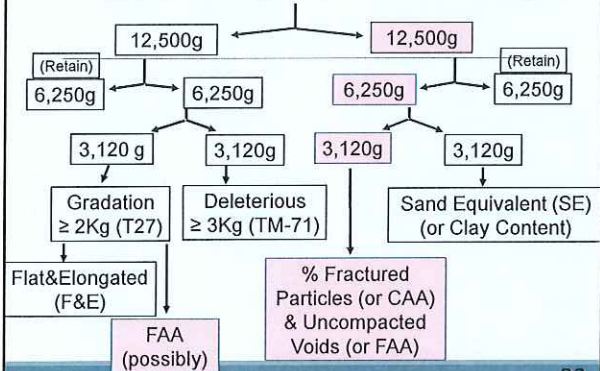

Sampling and Size Reduction

23

23

Consensus Tests Details

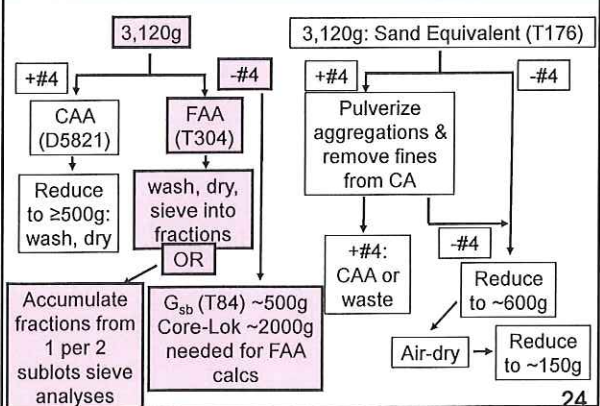

24

24

Split Over #4 Sieve

Plus #4: Coarse Aggregate (CA):

- CAA
- F&E

Minus #4: Fine Aggregate (FA):

- **FAA**
- SE

Sampling and Size Reduction 25

25

SAMPLE PREPARATION

- **Wash representative sample** (T 11)
Size of sample depends on gradation.
Generally, 500 –700g.
- Dry the washed sample at $230 \pm 9^\circ\text{F}$ ($110 \pm 5^\circ\text{C}$) to a constant weight.
- Sieve material (AASHTO T 27) and keep fractions separate.

Sample Preparation 26

26

- Remove the following size fractions and retain in separate labeled container:
 - Passing No. 8** – Retained on No. 16
 - Passing No. 16** – Retained on No. 30
 - Passing No. 30** – Retained on No. 50
 - Passing No. 50** – Retained on No. 100

Sample Preparation 27

27

- Weigh individual size fractions and combine them as follows (Record to the nearest 0.1 g):

Size Fraction	Mass, Grams
#8 – #16	44.0 ± 0.2
#16 – #30	57.0 ± 0.2
#30 – #50	72.0 ± 0.2
#50 – #100	17.0 ± 0.2
Total	190g ± 0.2

Sample Preparation

28

28

METHOD A

- When combined, the fractions form a **standard gradation** that weighs 190 ± 0.2g.

Sample Preparation

29

29

TEST PROCEDURE

- Mix combined material with spatula until homogeneous. Place a pan on towel and put the apparatus in the pan.
- Place finger under opening of funnel to seal opening.
- Pour sample into funnel and level with spatula.



Test Procedure

30

30

TEST PROCEDURE

cylinder mold = cylinder = measure = cylindrical measure



- Quickly remove finger from funnel and allow sample to free-fall into the calibrated cylindrical measure.
- Take care not to vibrate or disturb the material in the cylindrical measure to avoid further consolidation.

Test Procedure

31

31



- Strike off excess material in a single pass with the edge of spatula held in a vertical position.
- At this point additional compaction will not affect test results.
- Lightly tap cylinder using a spatula to consolidate and aid in handling.

Test Procedure

32

32

- After strike off, remove excess sand from the outside of the cylinder mold (measure) using a small brush.
- For each run, weigh the cylinder with sample and record to the nearest **0.1 gram**.
- Retain and recombine all material for a second trial.
- Record the mass of the empty measure to **0.1g**.
- The two results are averaged.

Test Procedure

33

33

- Repeat test using recombined sample.
- Calculate and report average of two trials.
- Experience has shown that variability in results decreases with operator experience and an increase in the number of trials performed.

34

CALCULATIONS & REPORTING

- Calculate the uncompacted voids for each determination.
- For Method A, calculate the average uncompacted voids for the two determinations and report the result as **U** to the nearest **0.1** percent.

35

- Calculate uncompacted voids as follows:

$$U = \left[\frac{V - \left(\frac{F}{G} \right)}{V} \right] \times 100$$

Where V = Volume of calibrated cylinder in ml
 F = Net mass of sample in cylinder
 (gross mass – empty cylinder)
 G = Bulk Dry Specific Gravity
 U = Uncompacted Voids in Percent

36

Aggregate Specific Gravity:

- Of the aggregate *blend* passing the #4 sieve.
- If any of the specific gravities of the blended materials differs by 0.05 from the typical specific gravity, the specific gravity of each fraction must be determined.

Calculations and Reporting

37

37

SPECIFIC GRAVITY Alternate Acceptable Methods

- Run T84 specific gravity of the T304 built specimen (best method).
- Run T84 on the minus #4 material off the combined cold feed.
- Calculate the weighted average (by % in the mix) specific gravity from results of T84 testing of the individual fractions in the mix that have previously been run (MoDOT runs T85 for a material with greater than 10% minus #4 and runs the T84 on the minus #4 material-these are averaged and reported as T85 specific gravity, but the T84 result is available).

38

38

Combined G_{sb}

$$G_{sb, \text{blend}} = \frac{P_1 + P_2 + P_3}{\frac{P_1}{G_{sb1}} + \frac{P_2}{G_{sb2}} + \frac{P_3}{G_{sb3}}}$$

P = % of each aggregate.

G_{sb} = T84 (minus #4) bulk specific gravity of each aggregate.

Calculations and Reporting

39

39

Combined G_{sb}

This is not equal to:

$$G_{sb} = P_1G_1 + P_2G_2 + P_3G_3\dots$$

Calculations and Reporting

40

40

UNFAVORABLE COMPARISON

- Of the four consensus tests, FAA is the most prone to "unfavorable comparison" because of inconsistent specific gravity (e.g., Just using G_{sb} from JMF).
- Other problem: non-washed specimen.

Calculations and Reporting

41

41

RESULTS

- Results of each individual trial and the final average is reported to the nearest tenth, **0.1%**.
- For comparison to MoDOT specifications, the final value of the averaged trials is rounded to the nearest whole number, **1%**.

Calculations and Reporting

42

42

EXAMPLE			
UNCOMPACTED VOID CONTENT OF FINE AGGREGATE aka: Fine Aggregate Angularity (FAA): Fine Aggregate Particle Shape (FAPS) AASHTO T 304: Test Method A			
Type of Material	Manufactured Sand		
Bulk Dry Specific Gravity [G _{sb}]	2.497		
STANDARD GRADATION All weights recorded to nearest 0.1 gram			
Sieve Size	Weight Retained (g)		Actual Weight Retained (g)
	Individual		Tolerance = ± 0.2 grams on each fraction
#16	44		44.2
#30	57		57.1
#50	72		72.0
#100	17		17.2
Calculations and Reporting			43

43

EXAMPLE				
UNCOMPACTED VOIDS CALCULATIONS				
	Trial 1	Trial 2	Trial 1	Trial 2
Weight of sand + measure (g)	318.0	316.4		
Weight of measure (g)	183.2	183.2		
Weight of sand (g) [F]	134.8	133.2		
Volume of measure (cm ³) [V]	99.8	99.8		
Uncompacted Voids (%) [U]*	45.9	46.5		
Average Uncompacted Voids (%)	46			
$U = \frac{V - \frac{F}{G_{sb}}}{V} \times 100$	$U = \left[\frac{99.8 - \left(\frac{134.8}{2.497} \right)}{99.8} \right] \times 100 = 45.9$		$U_{avg} = \frac{45.9 + 46.5}{2} = 46.2$	
Report: 46.2 compared to spec: 46				
Calculations and Reporting			44	

44

More Sample Problems	
Natural Sand	Manufactured Sand
F = 156.4 grams	F = 143.2 grams
G = 2.643	G = 2.735
Volume of cylinder is 99.9 ml	
Calculate Uncompacted Void Content	
Calculations and Reporting	
45	

45

Answer to Natural Sand

$$U = \frac{99.9 - (156.4 / 2.643)}{99.9} \times 100 = 40.7$$

Calculations and Reporting

46

46

Answer to Manufactured Sand

$$U = \frac{99.9 - (143.2 / 2.735)}{99.9} \times 100 = 47.5$$

Calculations and Reporting

47

47

Comparing to Specification

48

48

SECTION 304 CONSENSUS REQUIREMENTS on Blended Aggregate (5:1)				
Design Level	CAA Minimum	FAA Minimum	SE Minimum	F&E* Max
F	55/none	---	40	10
E	75/none	40	40	10
C	95/90	45	45	10
B	100/100	45	50	10

• SMA: $\leq 20\%$ @ 3:1 and $\leq 5\%$ @ 5:1

49

Common Testing Errors

- Improper calibration or damage to test cylinder resulting in a change of volume.
- Vibration in test area causing over-compaction of sample in test cylinder.

Erroneous specific gravity used in calculation.

- A difference of 0.05 specific gravity can cause an error of 1.0% FAA.

50

Appendix

VOLUME MEASURE CALIBRATION

51

Volume Measure Calibration "Informational"

Appendix 52

52

VOLUME MEASURE CALIBRATION

1. Apply grease to top edge of measure.



Volume Measure Calibration 53

53

2. Weigh measure + glass plate + grease.

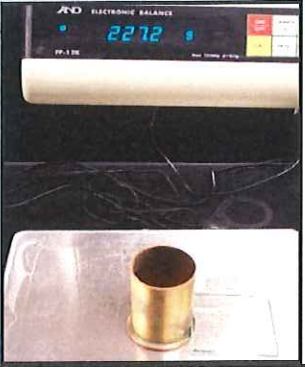

Volume Measure Calibration

54

3. Fill with freshly boiled & cooled (18-24 C) deionized water.

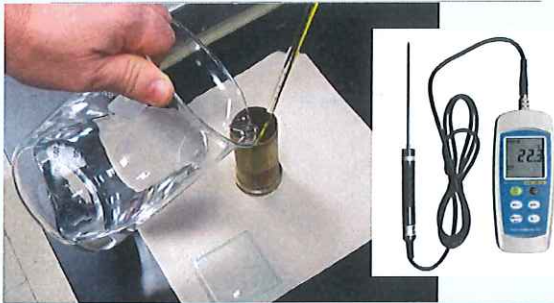

Volume Measure Calibration

55

55

4. Record water temperature.

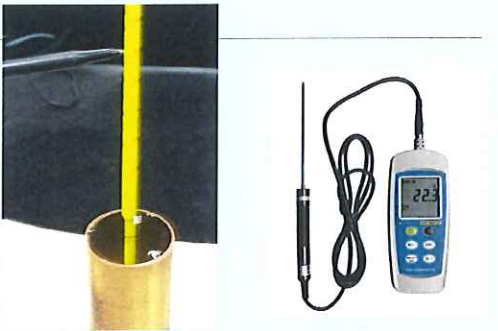

Volume Measure Calibration

56

56

5. Place plate on measure (avoid air bubbles)

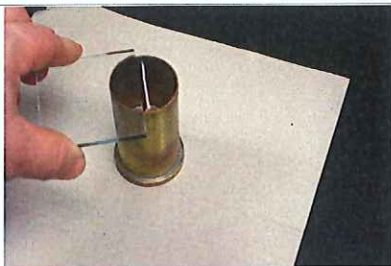

Volume Measure Calibration

57

57

6. Dry surface of measure



Volume Measure Calibration

58

58

7. Weigh measure + plate + grease + *water*



Volume Measure Calibration

59

59

8. Calculate the net mass of the water (M)

9. Look up density of water at test temperature (D).

10. Calculate (nearest 0.1 ml):

$$V = \frac{1000M}{D}$$

Volume Measure Calibration

60

60

DENSITY OF WATER

Temperature (°C)	Density (kg/m ³)
18.3	998.54
21.1	997.97
23.0	997.54
23.9	997.32

Volume Measure Calibration

61

61

Uncompacted Void Content of Fine Aggregate AASHTO T 304-17(2020): Method A

	Trial#	1	2	R																									
Material Preparation (state these requirements):																													
1. Split a cold-feed belt field sample over #4 sieve																													
2. Wash -#4 material over a #100 or #200 sieve and then oven-dry																													
3. Sieve oven-dry material into necessary size fractions																													
Test Sample Preparation:																													
4. Weigh out the following quantities and combine																													
<table border="1" style="width: 100%; border-collapse: collapse;"> <thead> <tr> <th style="width: 45%;">Individual Size Fractions</th> <th style="width: 25%;">Mass, g</th> <th style="width: 10%;">OK?</th> <th style="width: 10%;"></th> <th style="width: 10%;"></th> </tr> </thead> <tbody> <tr> <td>Pass #8, Retained #16</td> <td style="text-align: center;">44 ± 0.2</td> <td></td> <td></td> <td></td> </tr> <tr> <td>Pass #16, Retained #30</td> <td style="text-align: center;">57 ± 0.2</td> <td></td> <td></td> <td></td> </tr> <tr> <td>Pass #30, Retained #50</td> <td style="text-align: center;">72 ± 0.2</td> <td></td> <td></td> <td></td> </tr> <tr> <td>Pass #50, Retained #100</td> <td style="text-align: center;">17 ± 0.2</td> <td></td> <td></td> <td></td> </tr> </tbody> </table>					Individual Size Fractions	Mass, g	OK?			Pass #8, Retained #16	44 ± 0.2				Pass #16, Retained #30	57 ± 0.2				Pass #30, Retained #50	72 ± 0.2				Pass #50, Retained #100	17 ± 0.2			
Individual Size Fractions	Mass, g	OK?																											
Pass #8, Retained #16	44 ± 0.2																												
Pass #16, Retained #30	57 ± 0.2																												
Pass #30, Retained #50	72 ± 0.2																												
Pass #50, Retained #100	17 ± 0.2																												
Procedure:																													
5. Mix test sample with spatula until it appears homogeneous																													
6. Place funnel stand apparatus in clean, dry, non-warped retaining pan and center cylindrical measure under funnel																													
7. Block opening of the funnel with finger then pour test sample into the funnel																													
8. Using the spatula, level the material in the funnel with minimum effort.																													
9. Remove finger and allow material to fall freely into cylindrical measure while exercising care to avoid vibration/disturbance that could cause additional compaction of material in the measure																													
10. After funnel empties, and again being careful to avoid vibration, strike off excess aggregate with a single pass of the spatula with the width of the blade vertical using the straight part of its edge in light contact with the top of the cylindrical measure																													
11. After striking off excess aggregate, brush adhering material from the outside of the measure then obtain and record combined mass of measure and contents to the nearest 0.1 gram. NOTE: After strike-off, measure may be tapped lightly to compact sample to make it easier to transfer container to scale or balance without spilling any of the sample																													
12. Re-combine the sample from retaining pan and cylindrical measure and repeat the procedure (steps 5 through 11) for trial #2																													
13. Obtain and record mass of the empty cylindrical measure																													

Calculations:

14. Calculate uncompacted voids for trials #1 and #2 as follows:

$$U = \frac{V - \left(\frac{F}{G}\right)}{V} \times 100$$

Where: U = Uncompacted voids, nearest 0.1%
V = Volume of cylindrical measure, ml or cm³
G = Bulk dry specific gravity of fine aggregate
F = Mass of aggregate in cylindrical measure, g

15. Calculate average uncompacted voids (nearest 0.1%)

	PASS?		
	FAIL?		

Proctor _____ Date _____

Reviewer _____ Date _____

MODULE 4

ASTM D5821

PERCENT OF FRACTURED PARTICLES IN COARSE AGGREGATES

Fractured Face Count (FFC)
Coarse Aggregate Angularity (CAA)

MoDOT SUPERPAVE QC/QA
TRAINING/CERTIFICATION COURSE

**Fractured Face Count (FFC)
Coarse Aggregate Angularity
(CAA)**

ASTM D 5821

Determining the Percentage of Fractured
Particles in Coarse Aggregate

Revision 08/30/2022

1

- Scope
 - Significance and Use
 - Equipment
 - Sampling & Size Reduction
 - Sample & Specimen Preparation
 - Procedure
 - Calculations
 - Reporting
 - Comparing to Specification
- 2

2

SCOPE

This test procedure determines the amount (percent) of fracture faced rock particles by visual inspection.

Specifications contain minimum requirements for percentage of crushed rock particles.

Specifications apply to aggregate after the fractions have been combined (blended)

Scope 3

3

Introduction

- This method can be used to determine acceptability of coarse, dense graded, and open graded aggregates.
Primarily used for bituminous aggregates.

Scope

4

4

Terminology

- Fractured Face** – An angular, rough, or broken surface of an aggregate particle created by crushing, other artificial means, or by nature.
- Natural fractures can be accepted if they are similar to fractures produced by a crusher.

Scope

5

5

SIGNIFICANCE AND USE

- The purpose is to maximize shear strength in either bound or un-bound aggregate mixtures.
- Increased shear strength helps resist rutting.
- Provides stability for surface treatment aggregates and to provide increased friction and texture for aggregates used in pavement surface courses.

Significance and Use

6

6

Test Specifications

- This test method is primarily used on *gravel* products.
- Crushed limestone, dolomite, steel slag, and porphyry are considered to have 100 percent multiple (2 or more) fractured faces and will not be tested, unless visual inspection indicates that undesirable particle shapes are being produced.

Significance and Use

7

7

Test Specifications

- Refer to the Missouri Standard Specifications for Highway Construction Manual section 403 for the correct criteria.

Significance and Use

8

8

Coarse Aggregate Angularity (CAA) [Fractured Face Count (FFC)]



Significance and Use

9

9

CAA
Plus #4 Material on the Aggregate Blend

Percent Crushed Fragments in Gravels

0% Crushed 100% with 2 or More Crushed Faces

Significance and Use 10

10

EQUIPMENT

- No.4 (4.75mm) Sieve
- Balance – accurate to 0.1 g.
- Spatula or similar tool to help sort particles
- Proper containers to put the sorted particles in for weighing purposes.
- Sample size reduction device (e.g., riffle splitter)

Equipment 11

11

SAMPLING AND SIZE REDUCTION

- The test sample size is based on Nominal Maximum Size.
- Nominal Maximum Size is defined as the largest sieve upon which any material is retained.
- The mass of the test sample shall be large enough so that the largest particle is not more than 1% of the sample mass, or the test sample shall be at least as large as indicated in the following table, whichever is smaller.
- Sample mass $\geq 100 \times$ largest particle mass

Example: 6g rock \rightarrow 600g sample mass

12

12

SAMPLE PREPARATION

Nominal Maximum Size	Minimum Sample Mass
3/8" (9.5mm)	200 g (0.5lb.)
1/2" (12.5mm)	500 g (1 lb.)
3/4" (19.0mm)	1500 g (3 lbs.)
1" (25.0mm)	3000 g (6.5 lbs.)
1 1/2" (37.5mm)	7500 g (16.5 lbs.)
2" (50.0mm)	15,000 g (33 lbs.)

Sampling and Size Reduction 13

13

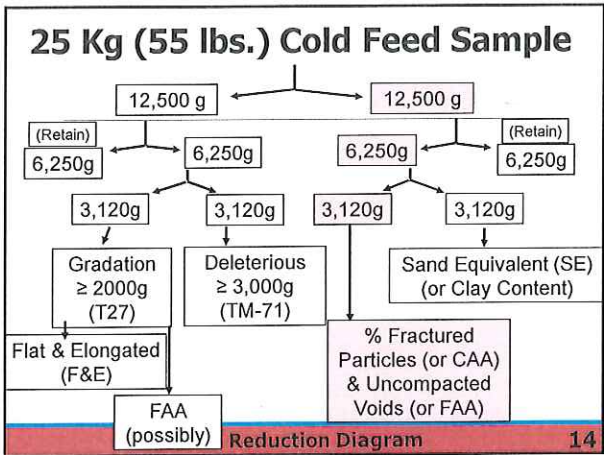

14

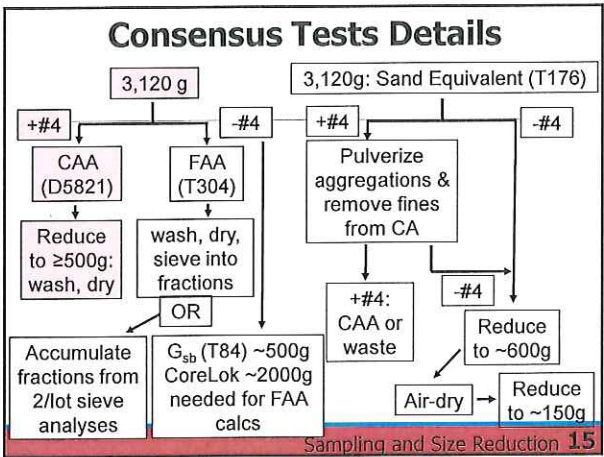

15

Split Over #4 Sieve

Plus #4: Coarse Aggregate (CA):

- CAA
- F&E



Minus #4: Fine Aggregate (FA):

- FAA
- SE

Sampling and Size Reduction

16

16

SAMPLE PREPARATION

- Dry the sample sufficiently to obtain a clean separation of fine and coarse material.
- Sieve the sample over a No.4 (4.75mm) sieve and keep what is retained on the sieve.
- Reduce the sample down using a splitter to the proper test size.

Sample Preparation

17

17

Option for Lessening the Amount of Material to Test:

- 1. Separate on the 3/8" sieve**
 - Split plus 3/8" material down to $\geq 1500g$
 - Test the plus 3/8" material
- 2. Separate the minus 3/8" material on the #4 sieve**
 - Split minus (3/8" to #4) material down to $\geq 200g$
 - Test the minus (3/8" to #4) material
- 3. Calculate the percent fractured face for each portion (+3/8" and 3/8"-to-#4)**
- 4. Report using weighted average.**

Sample Preparation

18

18

PROCEDURE

- Wash and dry plus #4 (4.75mm) material to a constant mass, 0.1% of the original dry sample mass.
- Spread sample on clean surface and evaluate each particle.
- The fractured face, when viewed directly, must constitute at least 25% of the maximum cross-sectional area.

Procedure

19

19

Fractured Face Count

Separate sample into 3 piles:

- Pile 1 - no fractured faces —
- Pile 2 - one fractured face
- Pile 3 - two or more fractured faces

Weigh all 3 piles

A face must be at least **25%** of the maximum particle cross-sectional outline to be a fractured face.

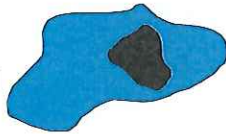

Procedure

20

20

Coarse Aggregate Angularity (CAA) [Fractured Face Count (FFC)]



Procedure

21

21

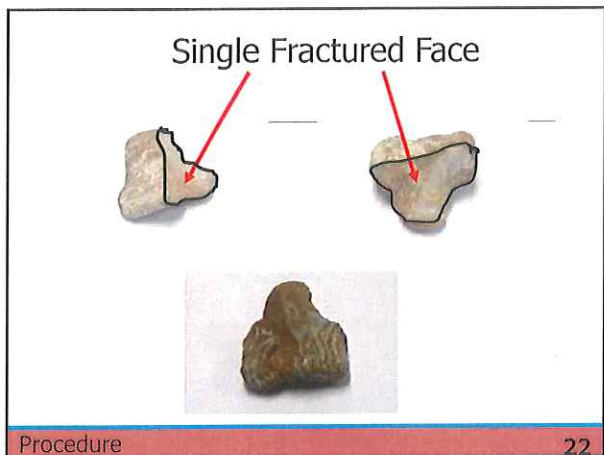

22

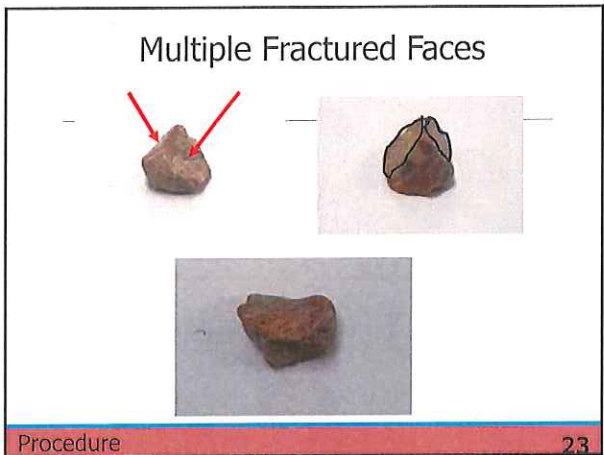

23

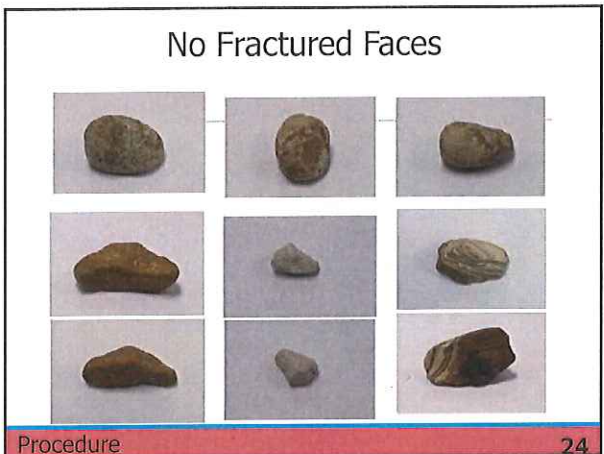

24

Judgment Call
1, 2, or 3?



Procedure 25

25

Judgment Call
Big Enough?

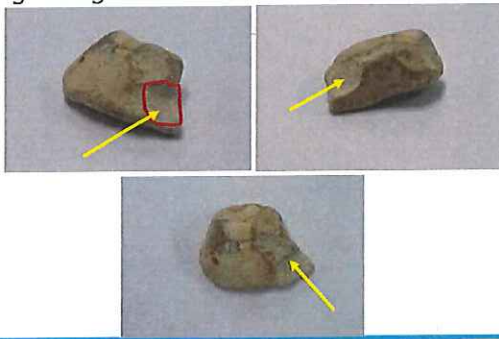

Procedure 26

26

CALCULATIONS

"Single"-face % FFC (at least one face)

(Sum of *all* particles with fractured faces):

$$P = \left[\frac{F_1 + F_2}{F_1 + F_2 + N} \right] \times 100$$

P = Percentage of particles with the specified number of fractured faces.

F₁ = Mass or count of fractured particles with one fractured face.

F₂ = Mass or count of fractured particles with 2 or more fractured faces

N = Mass or count of particles not meeting the fractured particle criteria.

Calculations

27

Multiple-face % FFC:

(Particles with **2 or more** fractured faces):

$$P = \left[\frac{F_2}{F_1 + F_2 + N} \right] \times 100$$

P = Percentage of particles with the specified number of fractured faces.

F₁ = Mass or count of fractured particles with one fractured face

F₂ = Mass or count of fractured particles with 2 or more fractured faces

N = Mass or count of particles not meeting the fractured particle criteria.

Calculations

28

28

REPORTING

The calculated results of the fractured faces are reported to the **nearest 1%**.

Reporting

29

29

EXAMPLE

Data Sheet – Fractured Face Count

Weight of particles with no Frac. Faces	N	93.2
Weight of particles with 1 Frac. Face	F1	52.2
Weight of particles with 2 or more Frac. Faces	F2	99.1
Single % FFC = $P = \left[\frac{F_1 + F_2}{F_1 + F_2 + N} \right] \times 100$		62
Multiple % FFC = $P = \left[\frac{F_2}{F_1 + F_2 + N} \right] \times 100$		41

Note that the single % FFC includes all the multiple faces.

30

30

EXAMPLE , cont'd.

$$P = \left[\frac{52.2 + 99.1}{52.2 + 99.1 + 93.2} \right] \times 100 = 62$$

$$P = \left[\frac{99.1}{52.2 + 99.1 + 93.2} \right] \times 100 = 41$$

31

31

Comparing to Specification

32

32

MoDOT MIXTURE TYPES

Design Levels	Design Traffic (ESALS)
F	< 3,000,000
E	300,000 to < 3,000,000
C	3,000,000 to < 30,000,000
B	≥ 30,000,000

33

33

SECTION 403 CONSENSUS REQUIREMENTS on blended aggregate (5:1)				
Design Level	CAA Minimum	FAA Minimum	SE Min	F&E* Max
F	55/none	---	40	10
E	75/none	40	40	10
C	95/90	45	45	10
B	100/100	45	50	10
* SMA: ≤ 20% @ 3:1 and ≤ 5% @ 5:1				34

34

SPECIFICATIONS
<p>75/- means the blend must have at least 75% one or more fractured faces and no requirement on multiple faces.</p> <p>95/90 means the blend must have at least 95% one or more fractured faces and at least 90% multiple faces.</p> <p>100/100 means the blend must have at least 100% one or more fractured faces and 100% multiple faces.</p>
35

35

APPENDIX

AASHTO T176 Appendix

EQUIPMENT

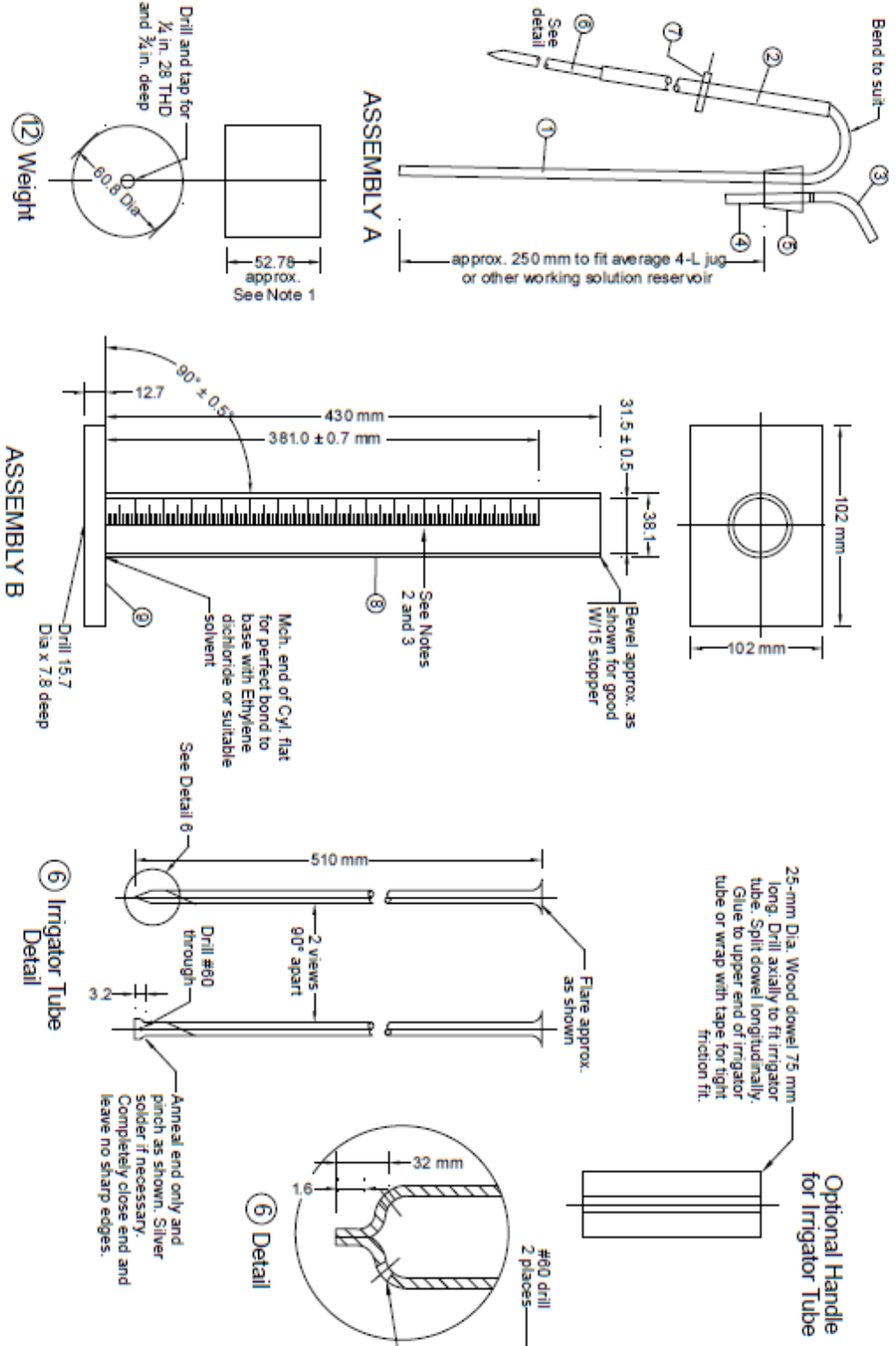

Note: All dimensions are shown in millimeters unless otherwise indicated.

Figure 1—Sand Equivalent Apparatus (Continued on next page)

TS-1a

T 176-3

AASHTO

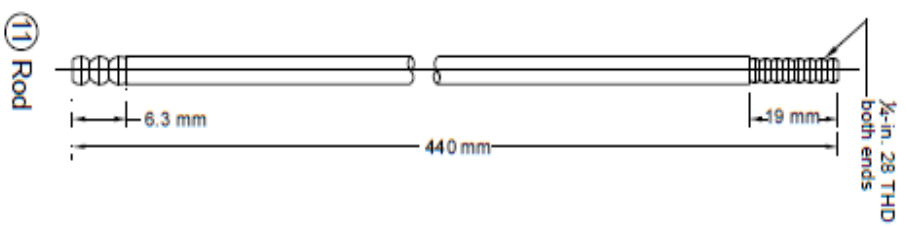
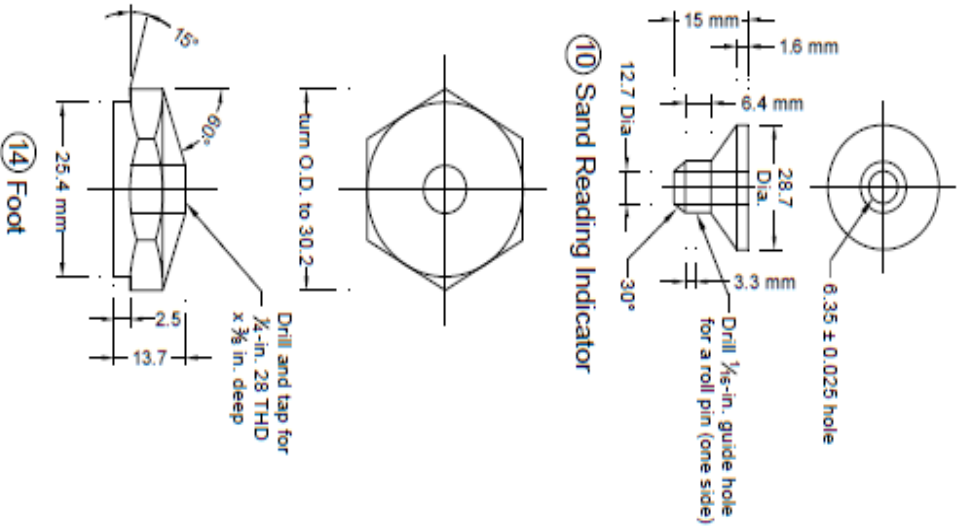

ASSEMBLY C

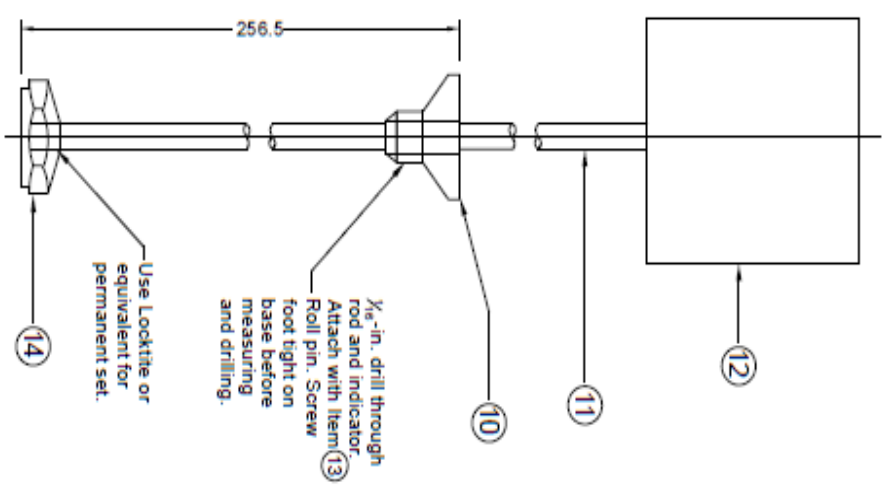

Note: All dimensions are shown in millimeters unless otherwise indicated.

Figure 1—Sand Equivalent Apparatus (Continued)

AASHTO T304 - FINE AGGREGATE ANGULARITY - APPENDIX

UNCOMPACTED VOID CONTENT OF FINE AGGREGATE FOP FOR AASHTO T 304

Scope

This Idaho Field Operating Procedure (FOP) covers a method for determining the loose uncompact void content of a sample of fine aggregate

Three procedures are included for the measurement of void content:

- Standard Graded Sample (Method A)
- Individual Size Fractions (Method B)
- As-Received Grading (Method C)

For Method A or C, the percent void content is determined directly and the average value of two test runs is reported.

For Method B, the mean percent void content is calculated using the results from each of the three individual size fractions.

AASHTO T304 - FINE AGGREGATE ANGULARITY - APPENDIX

Significance

Methods A and B provide percent void content determined under standardized conditions which depend on the particle shape and texture of a fine aggregate. An increase in void content by these procedures indicates greater angularity, less sphericity, rougher surface texture, or some combination of these three factors.

Method C measures the uncompacted void content of the minus No. 4 portion of the as-received material. This void content depends on grading as well as particle shape and texture.

The standard graded sample (**Method A**) is most useful as a quick test that indicates the particle shape properties of a graded fine aggregate. Typically, the material used to make up the standard graded sample can be obtained from the remaining size fractions after performing a single sieve analysis of the fine aggregate.

Obtaining and testing individual size fractions (**Method B**) is more time-consuming and requires a larger initial sample than using the graded sample. However, Method B provides additional information concerning the shape and texture characteristics of individual size fractions.

Testing samples in the as-received grading (**Method C**) may be useful in selecting proportions of the components used in a variety of mixtures. In general, high void content suggests that the material could be improved by providing additional fine aggregate or more binder may be needed to fill the voids between particles.

The bulk dry specific gravity of the fine aggregate (G_{sb}) is used to calculate the void content. The effectiveness of these methods of determining void content and its relationship to particle shape and texture depend on the bulk specific gravity of the various size fractions being equal (or nearly so).

Void content information from **Methods A, B, and C** may be a useful indicator of properties such as:

- Mixing water demand of hydraulic cement concrete.
- Flowability, pumpability, or workability of grouts and mortars.
- The effect of fine aggregate on stability, strength and VMA in bituminous concrete.
- Stability and strength of base course material.

AASHTO T304 - FINE AGGREGATE ANGULARITY - APPENDIX

Sample

The samples used for this test shall be obtained using AASHTO T 2 and AASHTO T 248, or from sieve analysis samples used for AASHTO T 27, or from an extracted bituminous concrete sample.

For Methods A and B, the sample is washed over a No. 100 or No. 200 sieve in accordance with AASHTO T 11 and then dried and sieved into separate size fractions according to AASHTO T 27. Maintain the necessary size fractions obtained from one or more sieve analyses in a dry condition in separate containers for each size.

For Method C, dry a split of the as-received sample in accordance with the drying provisions of AASHTO T 27.

Sample Preparation

Method A – Standard Graded Sample

Weigh out and combine the following quantities of fine aggregate that has been dried and sieved in accordance with AASHTO T 27.

<u>Individual Size Fraction</u>	<u>Mass, g</u>
Passing No. 8 to Retained on 16	44 ±0.2
Passing No. 16 to Retained on 30	57 ±0.2
Passing No. 30 to Retained on 50	72 ±0.2
Passing No. 50 to Retained on 10	<u>17 ±0.2</u>
	190 ±0.2

Method B – Individual Size Fractions

Prepare a separate 190 g sample of fine aggregate, dried and sieved in accordance with AASHTO T 27 for each of the following size fractions:

<u>Individual Size Fraction</u>	<u>Mass, g</u>
Passing No. 8 to Retained 16	190 ±1
Passing No. 16 to Retained 30	190 ±1
Passing No. 30 to Retained 50	190 ±1

Do not mix fractions together. Each size is tested separately.

AASHTO T304 - FINE AGGREGATE ANGULARITY - APPENDIX

Method C – As-received Grading

Pass the sample (dried in accordance with AASHTO T 27) through a No. 4 sieve. Obtain a 190 ± 1 g sample of this material for the test.

Specific Gravity of Fine Aggregate

If the bulk specific gravity (G_{sb}) of the fine aggregate sample is unknown, determine it according to Idaho IT-144.